

Sistema

**CT**

## Sistema CT

Sistema de correr com RPT - 60 mm

### Características do sistema

Sistema de alumínio com rotura térmica para execução de vãos de correr.

### Perfis de alumínio

Os perfis de alumínio são extrudidos na liga de alumínio 6060 para arquitectura de acordo com norma NP EN 12020-02.

Os perfis com rotura térmica são obtidos por inserção de varetas isolantes de poliamida 6.6 mm reforçadas com 25% de fibra de vidro. Versátil sistema de rotura térmica com aros e folhas perimetrais ou de corte recto designado por Benelux, é o sistema indicado para as inovadoras soluções arquitectónicas da actualidade.

Espessura média dos perfis de alumínio de 1.5 mm.

### Aros fixos

Perfis com rotura térmica obtida por inserção de varetas isolantes de poliamida de 14.6 mm ou 18 mm;

Perfil guia de deslizamento inferior em aço inoxidável 304 ou em poliamida, para evitar desgaste das peças.

### Aros móveis

Enchimento de 18 mm a 26 mm;

Aros móveis de linha recta;

Estanquidade assegurada através de junta em TPE e/ou pelúcia tipo Sin-Feal.

### Dimensionamento e manobralidade

Peso máximo de 150 kg por folha (com 2 rolamentos duplos);

Possibilidades de abertura: 2, 3, 4 e 6 folhas com folhas móveis e/ou fixas;

Rolamento duplo oscilante com regulação;

Rolamentos de agulhas inox com eixo temperado rectificadado sendo possível a substituição sem desmontagem da folha;

Suporte exterior com tratamento cataforese (anti-corrosivo);

Abertura do vão com fecho lateral ou ferragem multi-ponto com 2 ou 4 pontos de fecho.

### Performances

Sistema certificado por laboratório notificado do ensaio tipo inicial (ITT) de acordo com a norma de produto EN 14351-1 para efeitos de Marcação CE.

Categorias alcançadas na avaliação do sistema CT tipologia janela:

1. Permeabilidade ao ar: Classe 3 (norma de ensaio EN 1026)
2. Estanquidade à água: Classe 7A (norma de ensaio EN 1027)
3. Resistência ao vento: Classe C5 (norma de ensaio EN 12211)

Categorias alcançadas na avaliação do sistema CT tipologia porta:

1. Permeabilidade ao ar: Classe 4 (norma de ensaio EN 1026)
2. Estanquidade à água: Classe 7A (norma de ensaio EN 1027)
3. Resistência ao vento: Classe C2 (norma de ensaio EN 12211)

Coefficiente de transmissão térmica de vão de 2 folhas com 1.80 m x 2.20 m com vidro  $U_g = 1.0 \text{ W/m}^2\text{K}$  com intercalar efeito "Warm Edge":

•  $U_w = 1.91 \text{ W/m}^2\text{K}$

Coefficiente de atenuação acústica de vão de 2 folhas com vidro 6/14/33.1 acústico:

•  $R_w (C; C_{tr}) = 34 \text{ dB} (-1; -6)$

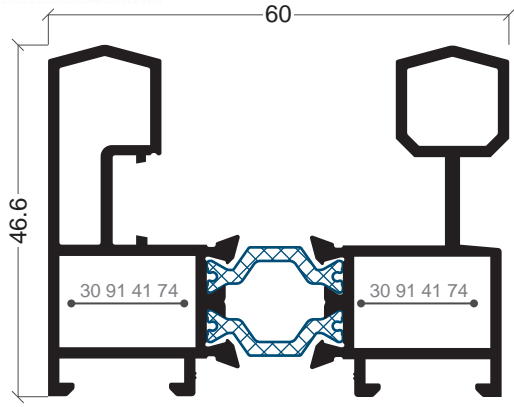

**CT-41**  
Aro fixo perimetral

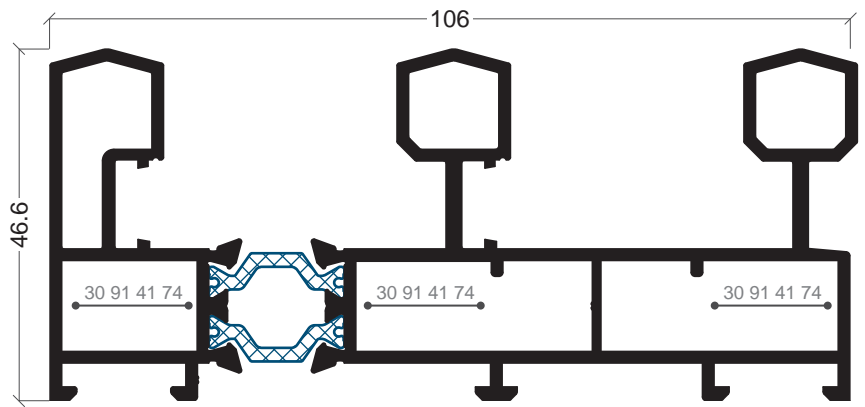

**CT-55**  
Aro fixo perimetral tri-rail

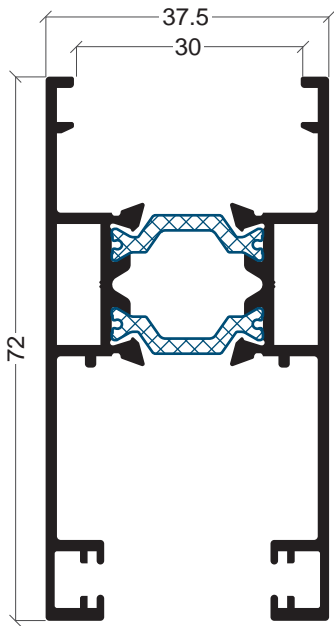

**CT-35**  
Aro móvel lateral

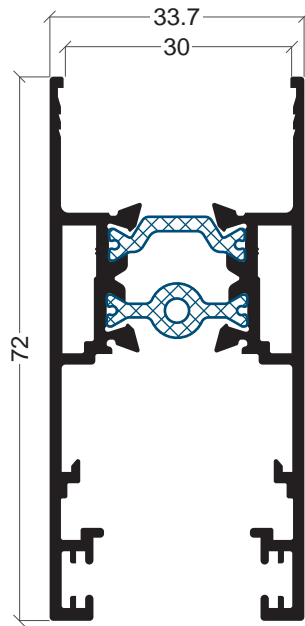

**CT-34**  
Aro móvel superior / inferior

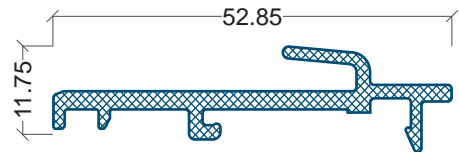

**CT-26**  
Cruzamento móvel

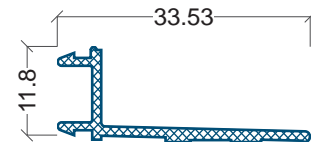

**CT-23**  
Tampa aro fixo perimetral

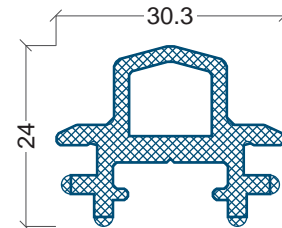

**CT-24**  
União 3/4 folhas CT-35/53

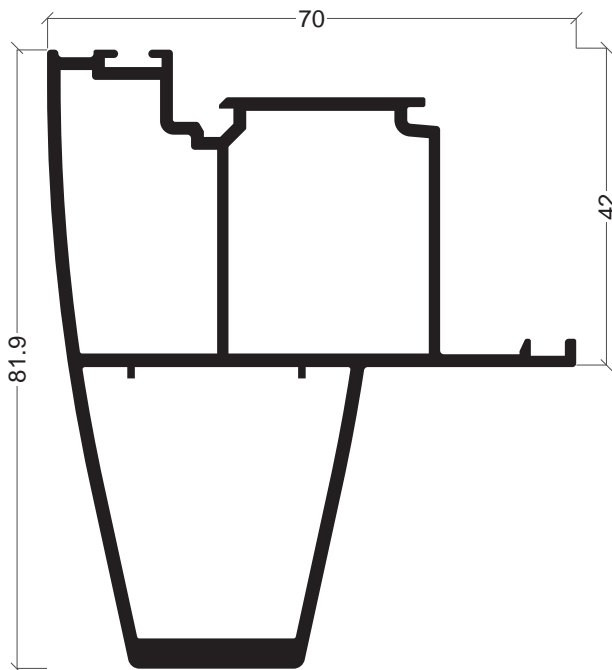

**CT-39**  
Aro móvel central com reforço

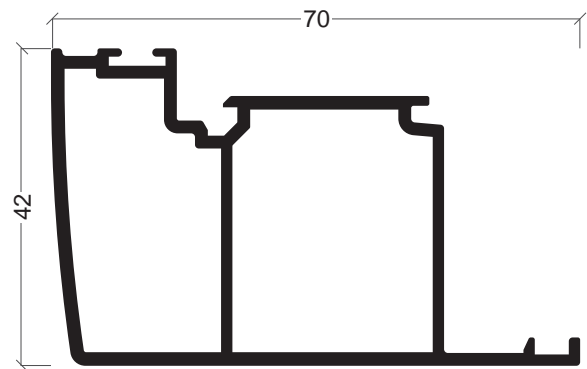

**CT-37**  
Aro móvel central

### Perfis alternativos

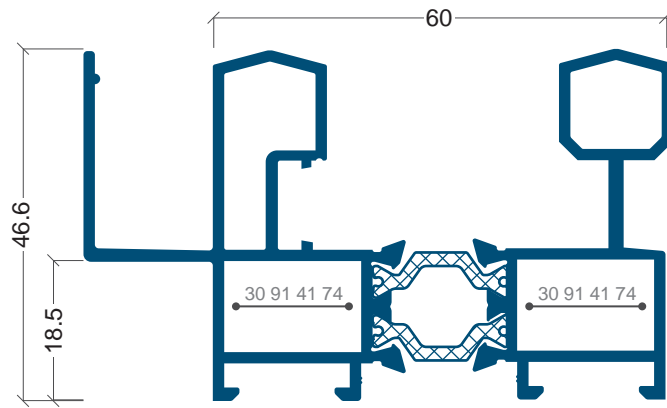

**CT-43**  
Aro fixo perimetral

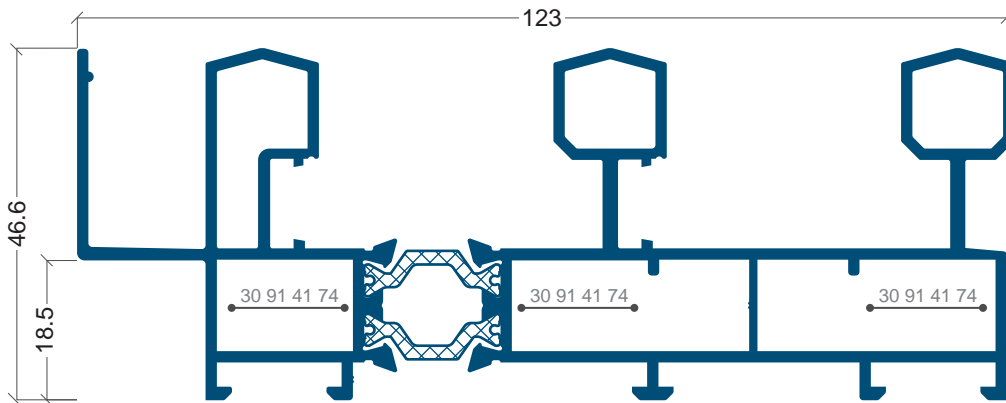

**CT-57**  
Aro fixo perimetral tri-rail

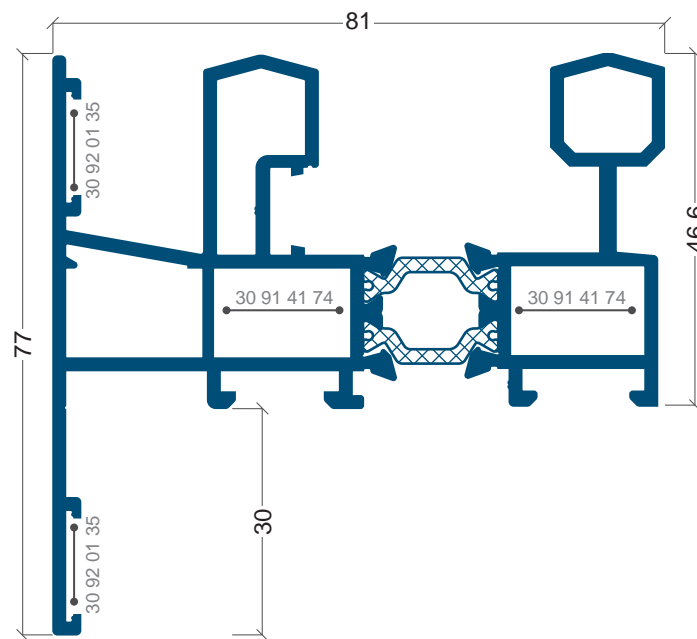

**CT-62**  
Aro fixo perimetral c/ aba remate

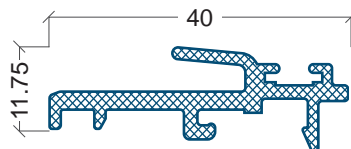
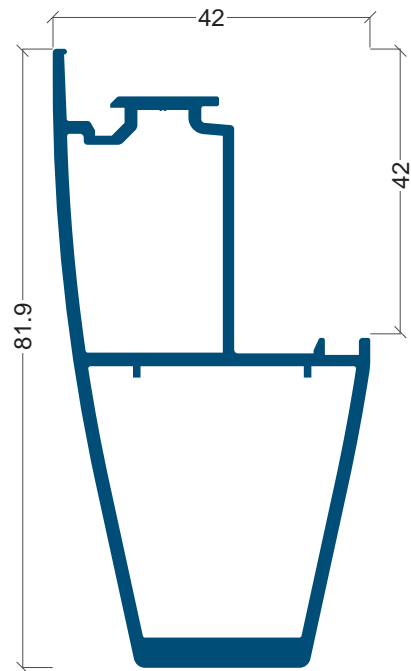
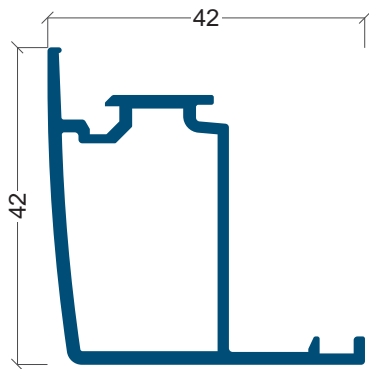
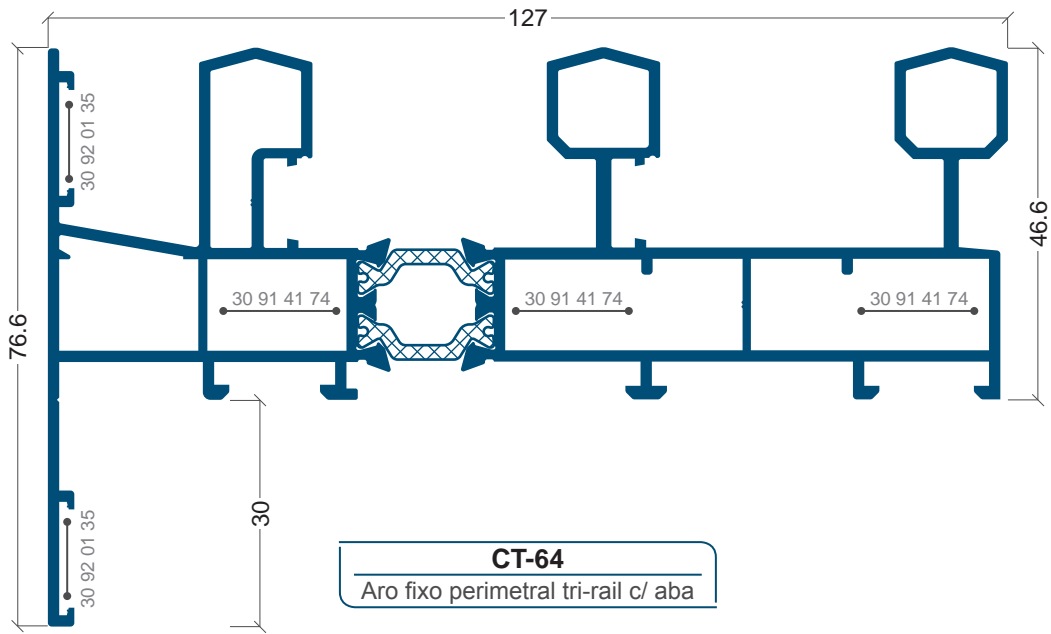

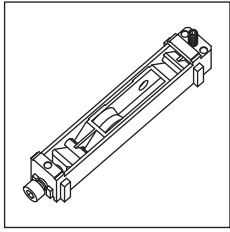

**30 91 40 35**

Rolamento simples  
(25Kg)

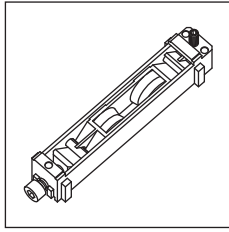

**30 91 40 36**

Rolamento simples  
(50Kg)

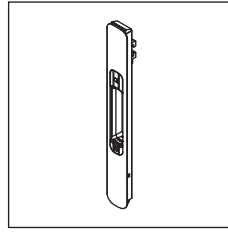

**DIN 4352**

Fecho lateral de embutir  
branco/preto

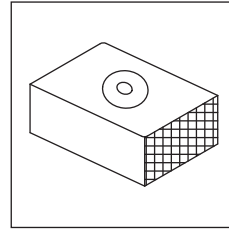

**30 91 41 10**

Taco anti-levantamento  
preto

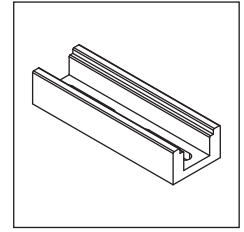

**30 91 41 24**

Calço nº 3 para multi-  
ponto inox

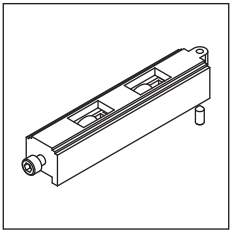

**30 91 41 49**

Rolamento duplo (75 kg)

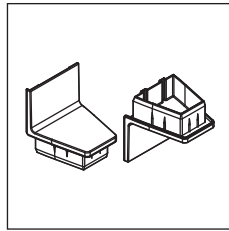

**30 91 41 67/68**

Jogo topos centrais  
(branco/preto)

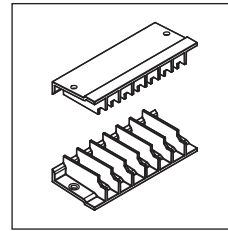

**30 91 41 70**

Corta ventos aro fixo Benelux  
(CT-02/12/37/39/53)

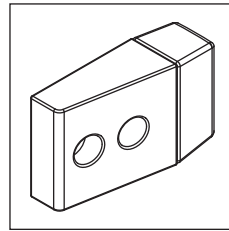

**30 91 41 71**

Topo limitador de  
abertura

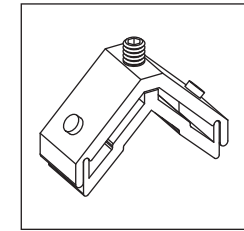

**30 91 41 74**

Esquadro aro fixo  
perimetral Benelux

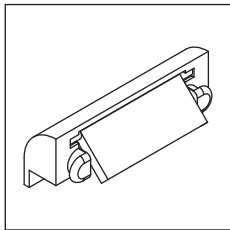

**30 92 01 02/03**

Goteira nylon c/ válvula  
preto / branco

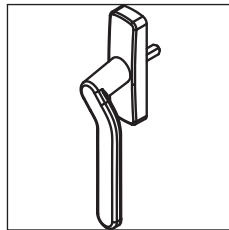

**DIN 4520**

Muleta desviada

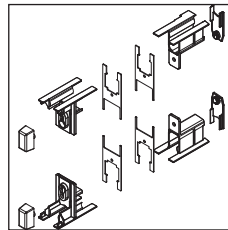

**30914182**

Kit topos de porta folhas  
laterais Benelux (1 folha)

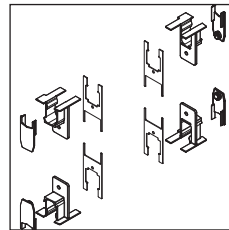

**30914183**

Kit topos de janela folha  
central Benelux (3ª folha)

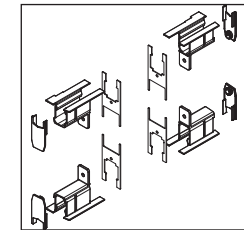

**30914184**

Kit topos de porta folha  
central Benelux (3ª folha)

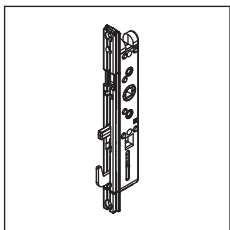

**30 92 07 30**

Ferragem MP regulável  
inox 1 ponto CT-35

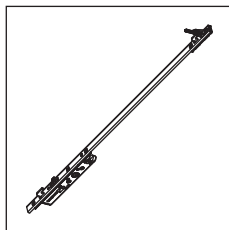

**30 92 07 35**

Ferragem MP regulável  
inox 2 pontos CT-35



**30 92 07 40**

Ferragem MP regulável  
inox 3 pontos CT-35

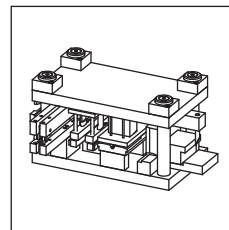

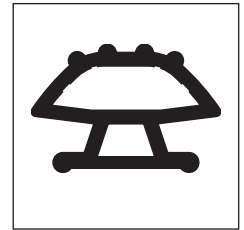

**33 94 30 00**

Cunho CT Benelux



**30 91 41 88**

Junta de Correr

Referência	Desenho	Descrição
30 91 41 88		Junta de correr
30 95 00 40		Pelúcia 7x5.5

## Janela 2 folhas correr

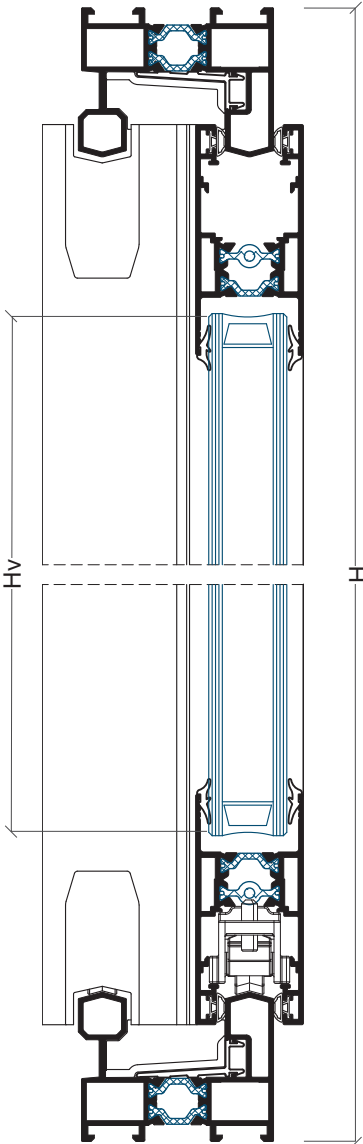
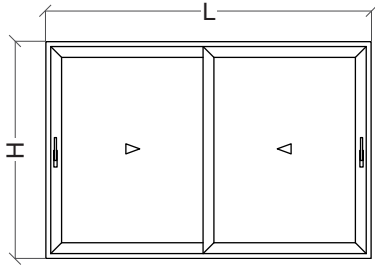

### Perfis

Desenho	Ref	Descrição	Corte	Quant	Medida
	CT-41	Aro fixo perimetral		1	L
				2	H
	CT-23	Tampa aro fixo		2	L-40 mm
				2	H-40 mm
	CT-34	Aro móvel superior/inferior		4	L/2-107 mm
	CT-35	Aro móvel lateral		2	H-73 mm
	CT-37	Aro móvel central		2	H-73 mm
	CT-26	Cruzamento móvel		2	H-73 mm

### Acessórios e Juntas

Referência	Descrição	Quantidade
30 91 40 35	Rolamento simples	4
30 91 41 10	Taco anti-levantamento	2
30 91 41 70	Jogo corta-ventos superior/inferior	1
30 91 41 74	Esquadro aro fixo	8
30 91 41 82	Kit topos janela	2
30 91 41 88'	Junta de correr	4L+6H
30 92 01 02/03	Goteiras (preto/branco)	2
DIN 4352	Fecho lateral	2
---	Junta vidro	4L+8H

\* pelúcia alternativa ref.: 30 95 00 40

75

### Vidro



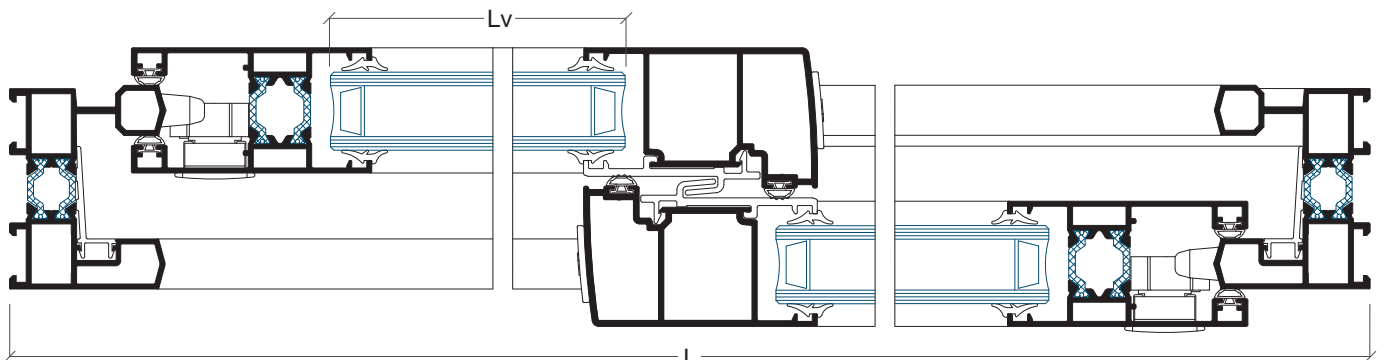



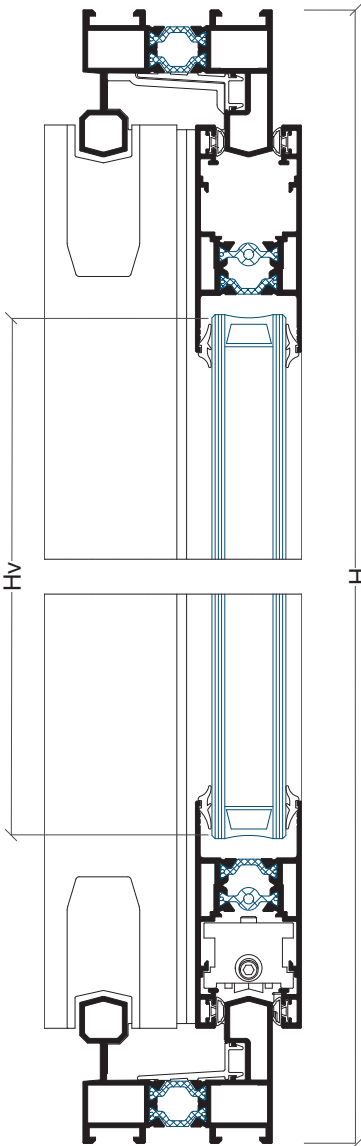
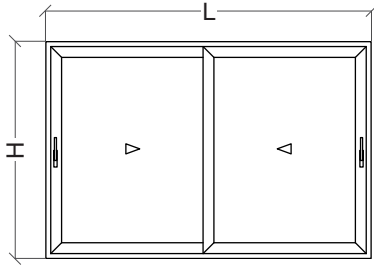



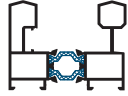





Hv = H-192 mm	Lv = L/2-110 mm
---------------	-----------------



## Porta 2 folhas correr multiponto



### Perfis

Desenho	Ref	Descrição	Corte	Quant	Medida
	CT-41	Aro fixo perimetral		1	L
				2	H
	CT-23	Tampa aro fixo		2	L-40 mm
				2	H-40 mm
	CT-34	Aro móvel superior/inferior		4	L/2-107 mm
	CT-35	Aro móvel lateral		2	H-73 mm
	CT-37	Aro móvel central		1	H-73 mm
	CT-39	Aro móvel central com reforço		1	H-73 mm
	CT-26	Cruzamento móvel		2	H-73 mm

### Acessórios e Juntas

Referência	Descrição	Quantidade
30 91 41 24	Calço nº3 multiponto	16
30 91 41 49	Rolamento duplo reforçado	4
30 91 41 61	Ponto de fecho	6
30 91 41 67	Jogo topo central	1
30 91 41 70	Jogo corta-ventos superior/inferior	1
30 91 41 71	Limitador de abertura	1
30 91 41 74	Esquadro aro fixo	8
30 91 41 82	Kit topos porta	2
30 91 41 88*	Junta de correr	4L+6H
30 92 01 02/03	Goteiras (preto/branco)	2
30 92 07 40	Ferragem 3 pontos	2
DIN 4520	Muleta desviada direita	1
DIN 4520	Muleta desviada esquerda	1
---	Junta vidro	4L+8H

\* pelúcia alternativa ref.: 30 95 00 40

### Vidro

Hv = H-192 mm	Lv = L/2-119 mm
---------------	-----------------

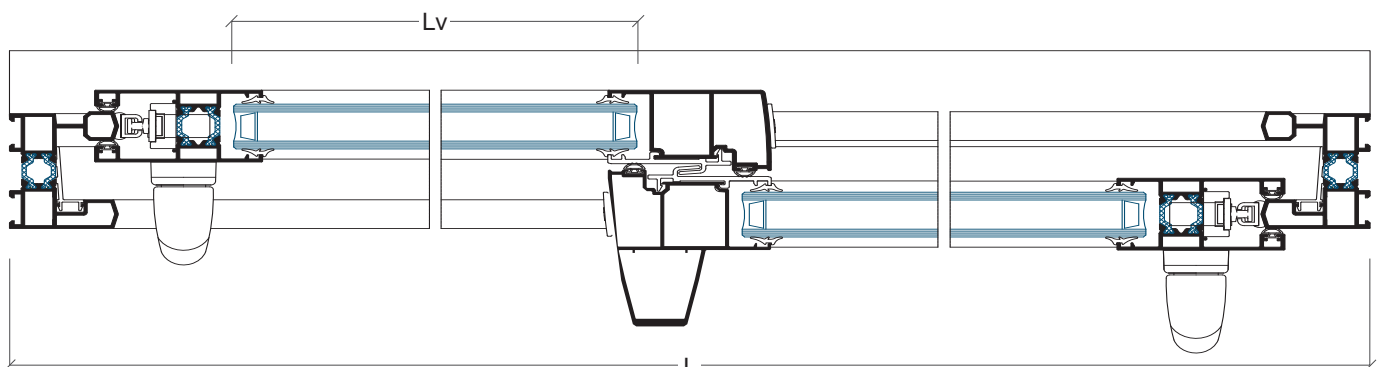



## Janela 3 folhas correr tri-rail

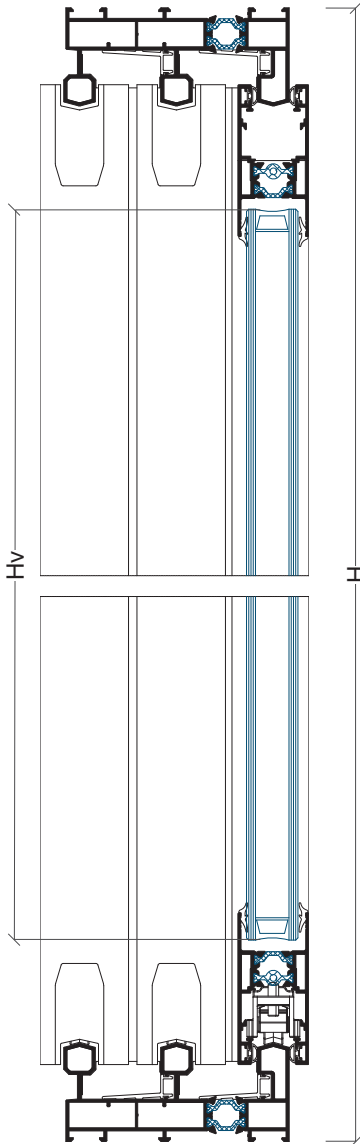
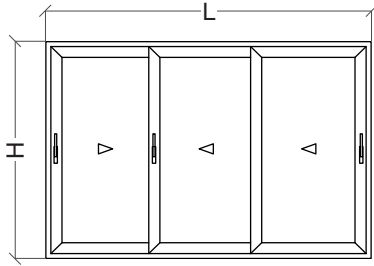

### Perfis

Desenho	Ref	Descrição	Corte	Quant	Medida
	CT-55	Aro fixo perimetral		2	L
				2	H
	CT-23	Tampa aro fixo		4	L-40 mm
				4	H-40 mm
	CT-34	Aro móvel superior/inferior		6	L/3-83 mm
	CT-35	Aro móvel lateral		2	H-73 mm
	CT-37	Aro móvel central		4	H-73 mm
	CT-26	Cruzamento móvel		4	H-73 mm

### Acessórios e Juntas

Referência	Descrição	Quantidade
30 91 40 35	Rolamento simples	6
30 91 41 69	Jogo cortaventos superior/inferior	2
30 91 41 74	Esquadro aro fixo	12
30 91 41 81	Kit topos janela folhas laterais	2
30 91 41 83	Kit topos janela folhas centrais	1
30 91 41 88*	Junta de correr	4L+8H
30 92 01 02/03	Goteiras (preto/branco)	2
DIN 4352	Fecho lateral	2

\* pelúcia alternativa ref.: 30 95 00 40

### Vidro



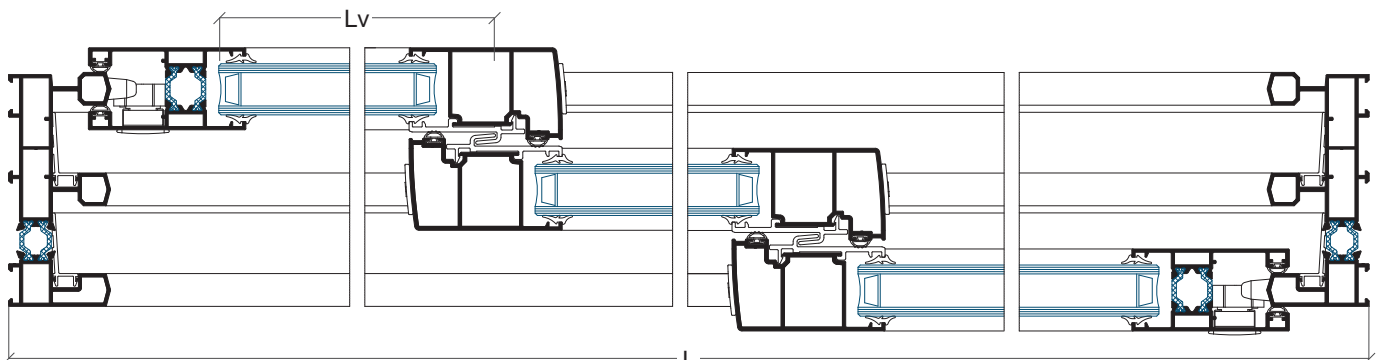



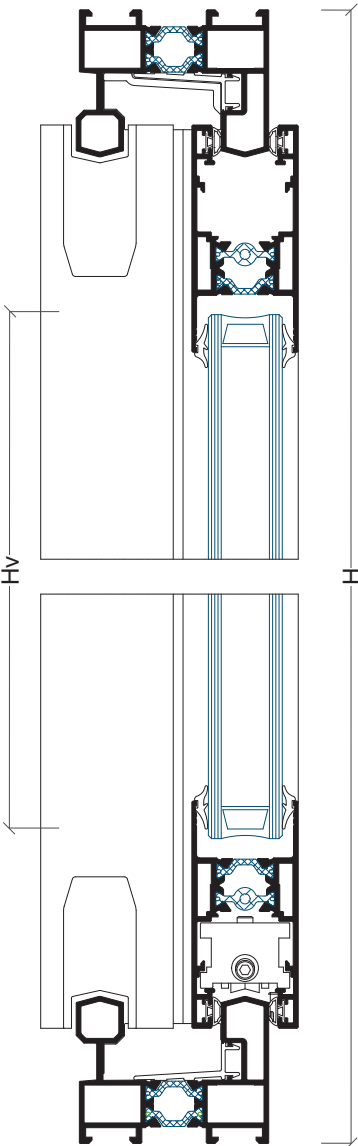
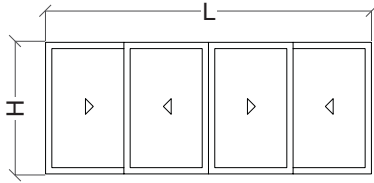



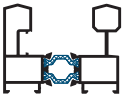





Hv = H-192 mm	Lv = L/3-93 mm
---------------	----------------



## Janela 4 folhas correr



### Perfis

Desenho	Ref	Descrição	Corte	Quant	Medida
	CT-41	Aro fixo perimetral		2	L
				2	H
	CT-23	Tampa aro fixo		4	L-40 mm
				4	H-40 mm
	CT-34	Aro móvel superior/inferior		8	L/4-90 mm
	CT-35	Aro móvel lateral		4	H-73 mm
	CT-37	Aro móvel central		4	H-73 mm
	CT-26	Cruzamento móvel		4	H-73 mm
	CT-24	União 3/4 folhas		1	H-73 mm

### Acessórios e Juntas

Referência	Descrição	Quantidade
30 91 40 35	Rolamento simples	8
30 91 41 10	Taco anti-levantamento	3
30 91 41 24	Calços	3
30 91 41 70	Corta-ventos inferior/superior	3
30 91 41 74	Esquadro aro fixo	8
30 92 01 02/03	Goteiras (preto/branco)	4
30 95 00 40*	Pelúcia 7x5.5 mm	4L+10H
DIN 4510	Puxador muleta	3
-----	Ferragem multiponto	3
-----	Junta vidro	4L+16H

\* junta alternativa ref.: 30 91 41 88

### Vidro

Hv = H-192 mm	Lv = L/4-100 mm
---------------	-----------------

