

**Sistema**

**XP**

## Sistema XP

### Sistema de Portadas

#### Características do sistema

Sistema de portada que oferece a possibilidade lâminas fixas.

Este sistema não utiliza inversores graças à fisionomia da folha, utilizando apenas um pequeno perfil de batente.

#### Perfis de alumínio

As secções do aro e do móvel são de 40 e 47 mm respectivamente, com uma espessura média dos perfis de alumínio de 1.5 mm.

#### Dimensionamento e manobralidade

Possibilidades de abertura: exterior (1, 2, 3 e 4 folhas), harmónio e correr.

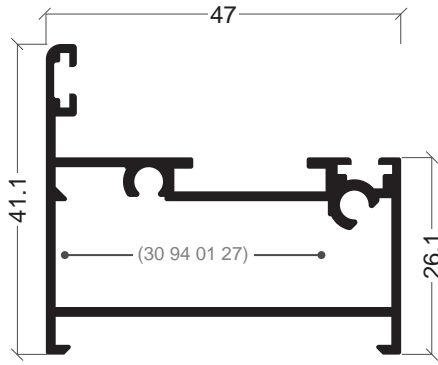

**XP-03**  
Aro fixo

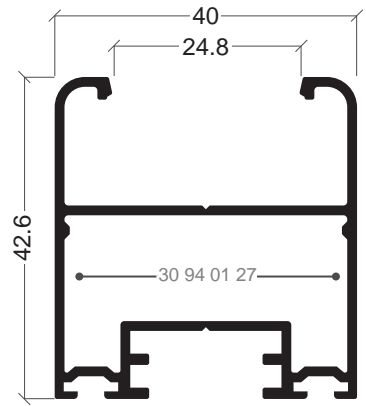

**XP-05**  
Aro móvel

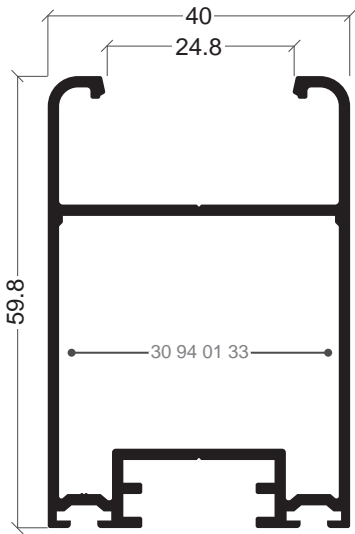

**XP-18**  
Aro móvel

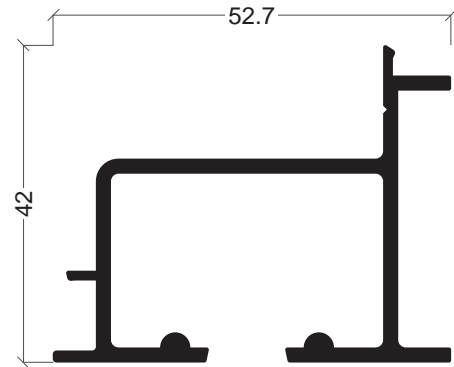

**XP-07**  
Guia superior de correr

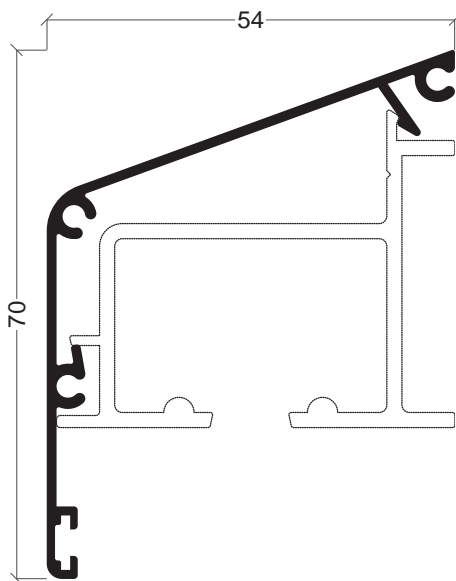

**XP-06**  
Tampa guia superior de correr

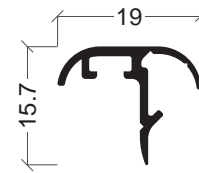

**XP-04**  
Perfil de batente

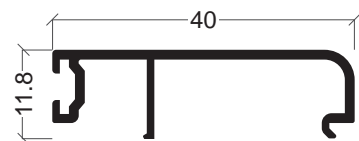

**XP-08**  
Tampa lateral de correr

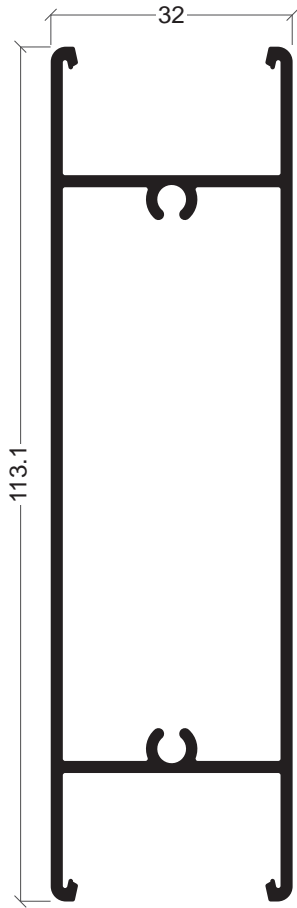

**XP-27**  
Travessa 113 mm

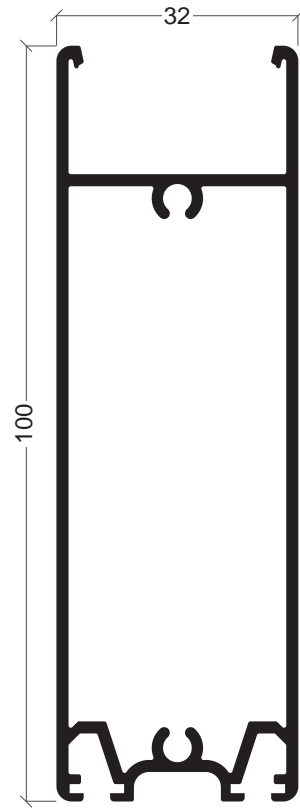

**XP-16**  
Almofada 100 mm

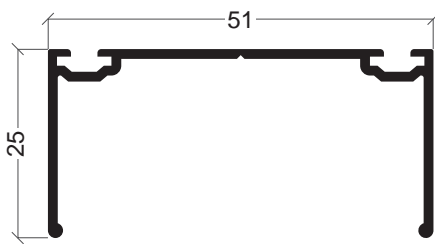

**XP-20**  
Distanciador aro fixo de correr

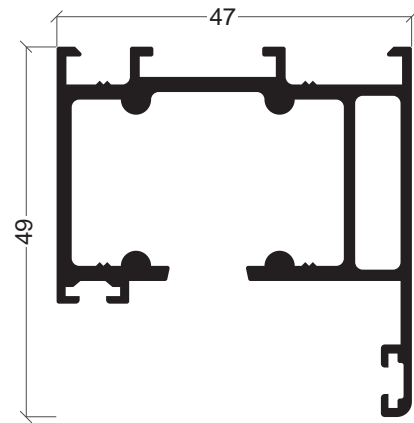

**XP-21**  
Aro fixo de correr

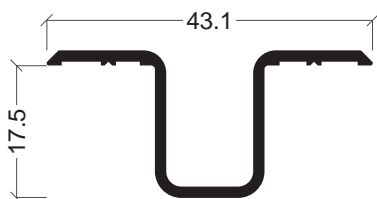

**XP-23**  
Guia embutir de correr

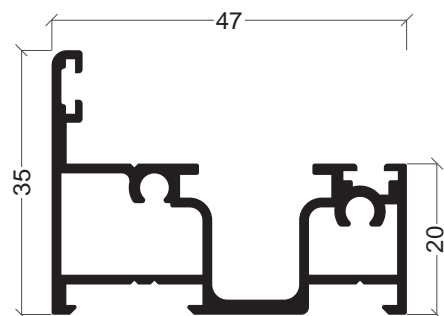

**XP-24**  
Aro fixo guia de correr

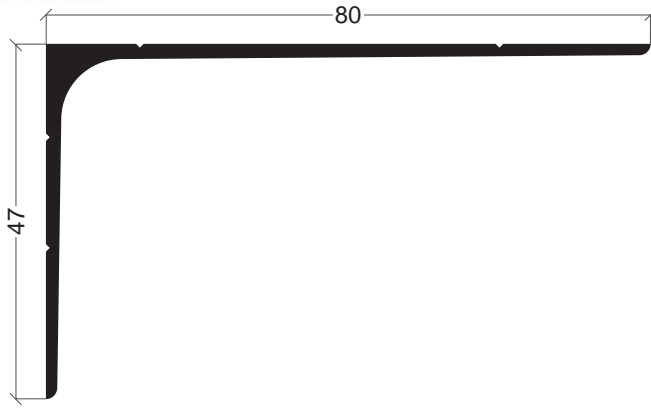

**XP-15**  
Guia inferior de correr

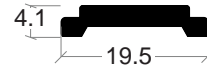

**OK-19**  
Vareta PVC

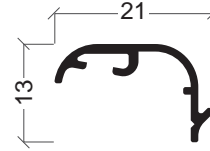

**XP-17**  
Perfil batente de correr

**Perfis alternativos**

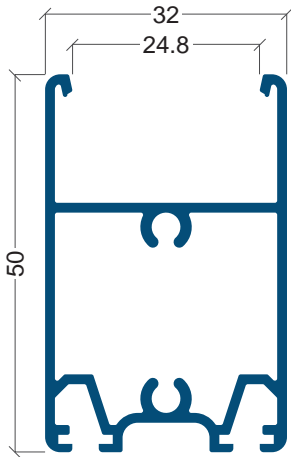

**XP-10**  
Almofada 50 mm

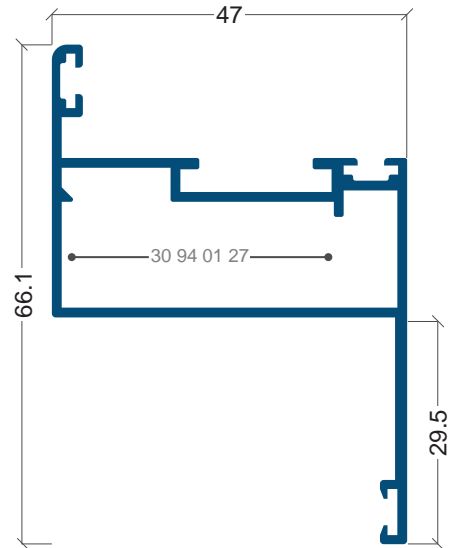

**XP-26**  
Aro fixo com remate

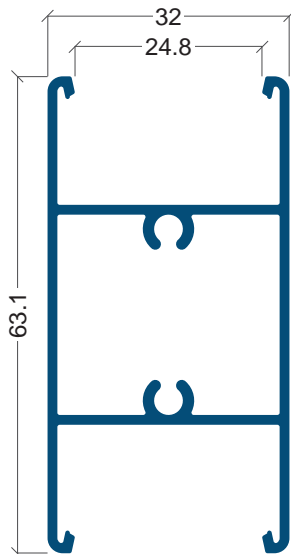

**XP-25**  
Travessa 63 mm

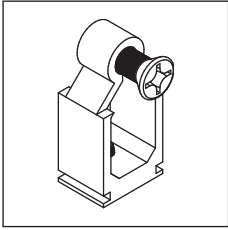

**30 92 01 40**

União topos janela

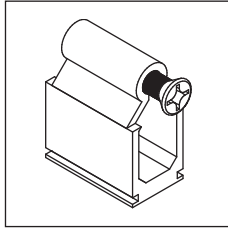

**30 92 01 50**

União topos porta

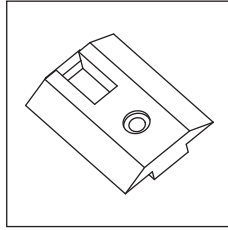

**30 94 01 02**

Complemento de fecho

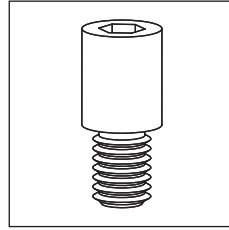

**30 94 01 04**

Jogo parafusos  
distanciadores

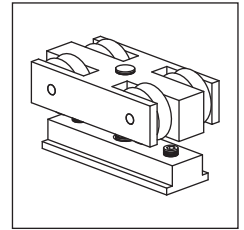

**30 94 01 05**

Rolamentos

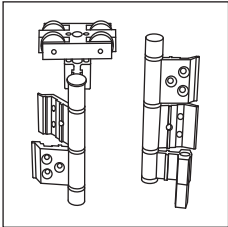

**30 94 01 06/14**

Rolamento e dobradiça  
harmônio (branco/preto)

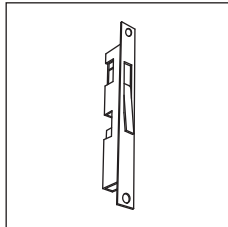

**30 94 01 07/15**

Fecho de embutir  
(branco/preto)

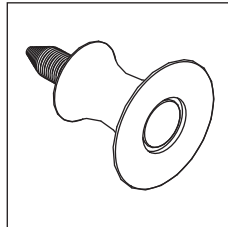

**30 94 01 08/16**

Aplique fixador (branco/  
preto)

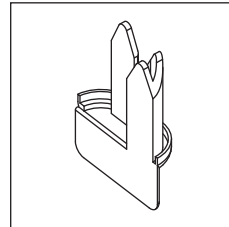

**30 94 01 12/20**

Jogo topos perfil batente  
(branco/preto)

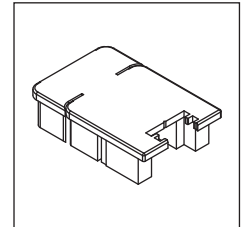

**30 94 01 13/21**

Tampa aro móvel  
(branco/preto)

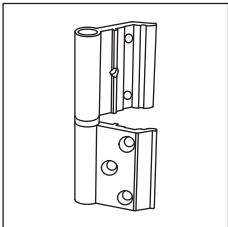

**30 94 01 24/30**

Dobradiça XP 1ª/2ª folha

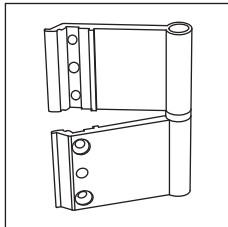

**30 94 01 25/31**

Dobradiça XP 3ª/ 4ª folha

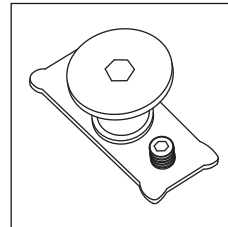

**30 94 01 26**

Distanciador aro

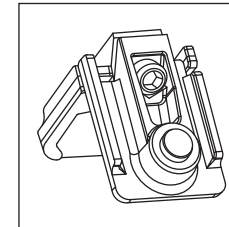

**30 94 01 27**

Esquadro janela

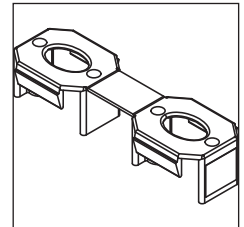

**30 94 01 32**

Distanciador travessa

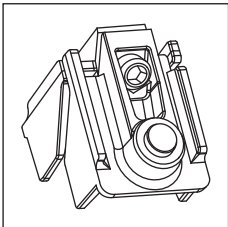

**30 94 01 33**

Esquadro porta

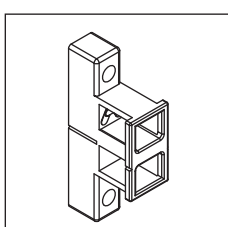

**30 94 01 34**

Fecho superior correr

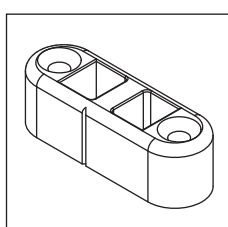

**30 94 01 35**

Fecho inferior correr

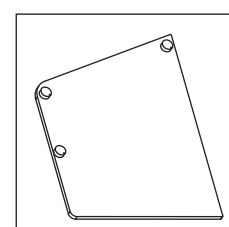

**30 94 01 36**

Tampa lateral correr  
54 mm

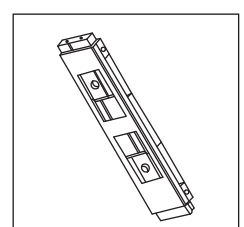

**30 94 01 39**

Kit fixação cremone  
abertura exterior

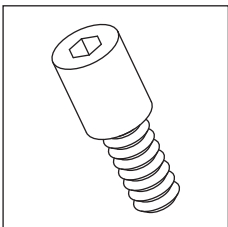

**30 94 01 40**

Distanciador abertura  
exterior 14 mm

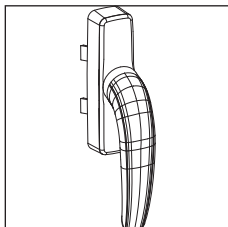

**DIN 4131**

Cremone abertura  
exterior

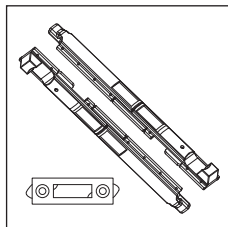

**DIN 5040**

Fecho 2ª folha 5040

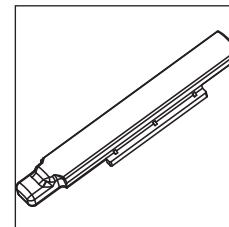

**DIN 5099**

Ponteira

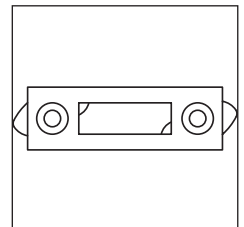

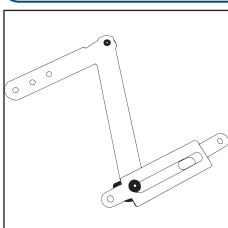

**DIN 5101**

Terminal duplo



**DIN 10001 Inox**





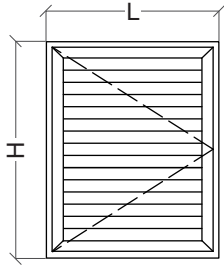

Fixador portada

Referência	Desenho	Descrição
30 94 01 46		Junta int./ext.
30 95 00 10		Pelúcia 7x9mm
30 95 00 30		Pelúcia 7x7mm

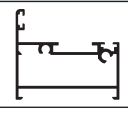
## Janela 1 folha abertura exterior

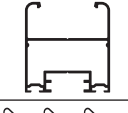

### Perfis

Desenho	Ref	Descrição	Corte	Quant	Medida
	XP-03	Aro fixo		1	L
				2	H
	XP-05	Aro móvel de janela		2	L-64 mm
				2	H-37 mm
	Z-20	Lâmina		Segundo altura	L-163 mm

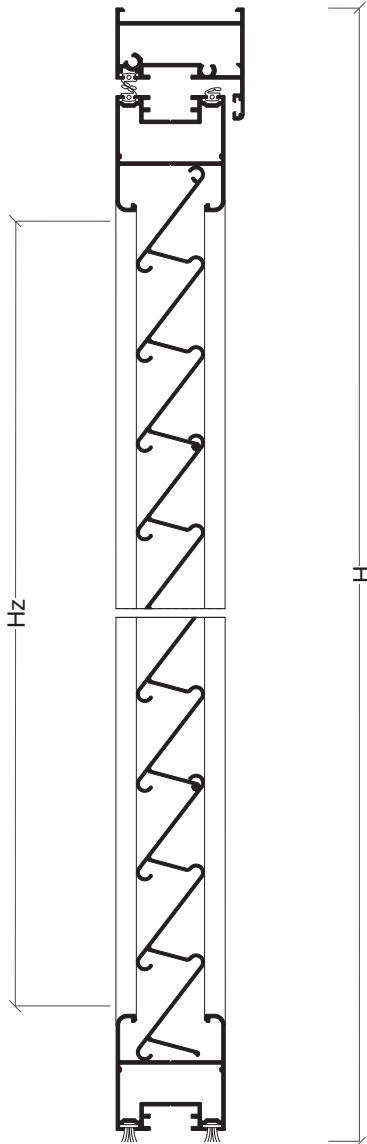

### Acessórios e Juntas

Referência	Descrição	Quantidade
30 94 01 02	Complemento fecho de portada	1
30 94 01 24	Dobradiça XP 1ª/2ª folha	2
30 94 01 27	Esquadro de janela	6
30 94 01 40	Distanciador 14mm abertura exterior	2
30 94 01 46	Junta interior/exterior	3L+6H
30 95 00 30	Pelúcia 7x7mm	2L
DIN 4131	Cremone abertura exterior	1
DIN 5099	Ponteira	1
DIN 5101	Terminal duplo	2
DIN 10001 Inox	Fixador de portada	1

33

### Portalâminas



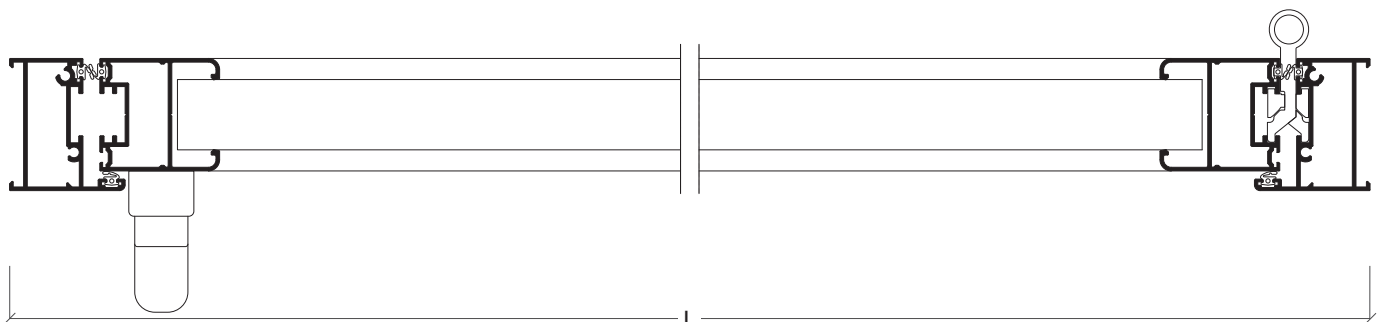



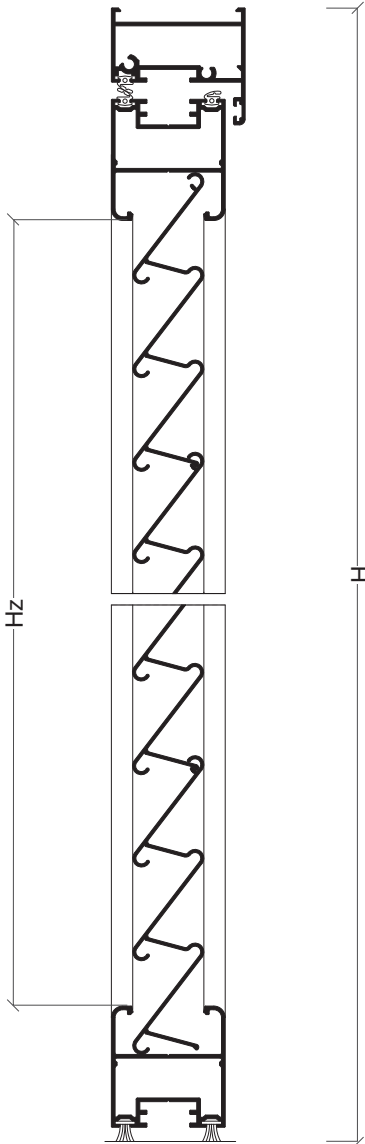
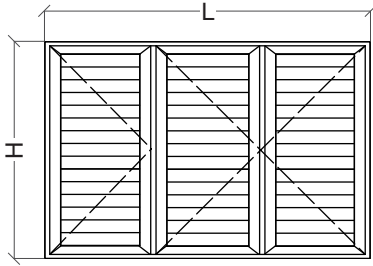



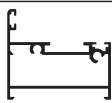

$H_z = H - 122 \text{ mm}$
----------------------------



## Janela 3 folhas abertura exterior



### Perfis

Desenho	Ref	Descrição	Corte	Quant	Medida
	XP-03	Aro fixo		1	L
				2	H
	XP-05	Aro móvel de janela		4	Lat. = L/2-37 mm
				2	Cen. = L/3-42 mm
				6	H-37 mm
	Z-20	Lâmina		Segundo altura	Lat. = L/3-116 mm
				Segundo altura	Cen. = L/3-141 mm
	XP-04	Perfil de batente		2	H-37 mm

### Acessórios e Juntas

Referência	Descrição	Quantidade
30 94 01 02	Complemento fecho de portada	2
30 94 01 10	Fixador de portada 3/4 folhas (opcional)	1
30 94 01 12	Jogo topos para perfil batente	3
30 94 01 24	Dobradiça XP 1 <sup>ª</sup> /2 <sup>a</sup> folha	4
30 94 01 25	Dobradiça XP 3 <sup>ª</sup> /4 <sup>a</sup> folha	2
30 94 01 27	Esquadro de janela	14
30 94 01 40	Distanciador 14mm abertura exterior	2
30 94 01 46	Junta interior/exterior	2L+3L/3+11H
30 95 00 30	Pelúcia 7x7mm	6L/2
DIN 4131	Cremona abertura exterior	1
DIN 5040	Fecho 2 <sup>a</sup> folha	4
DIN 5099	Ponteira	1
DIN 5101	Terminal duplo	2
DIN 10001 Inox	Fixador de portada (opcional)	1

### Portalâminas

Hz = H-122 mm

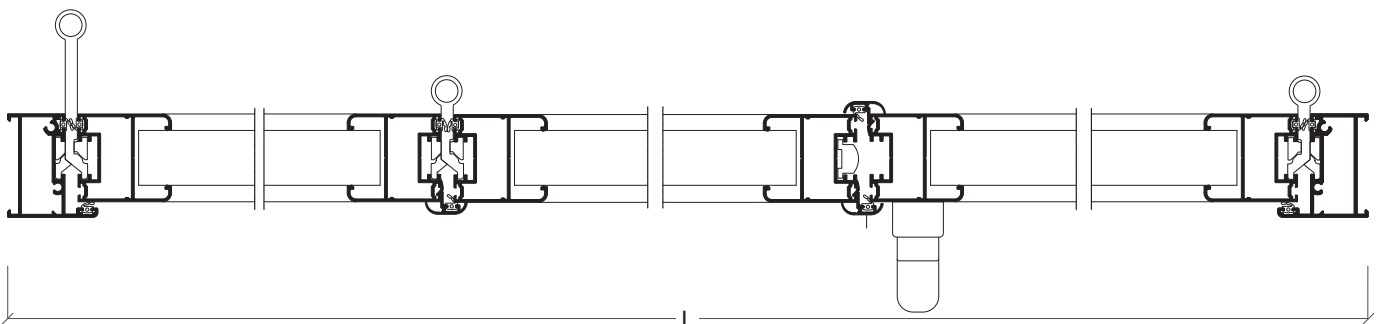





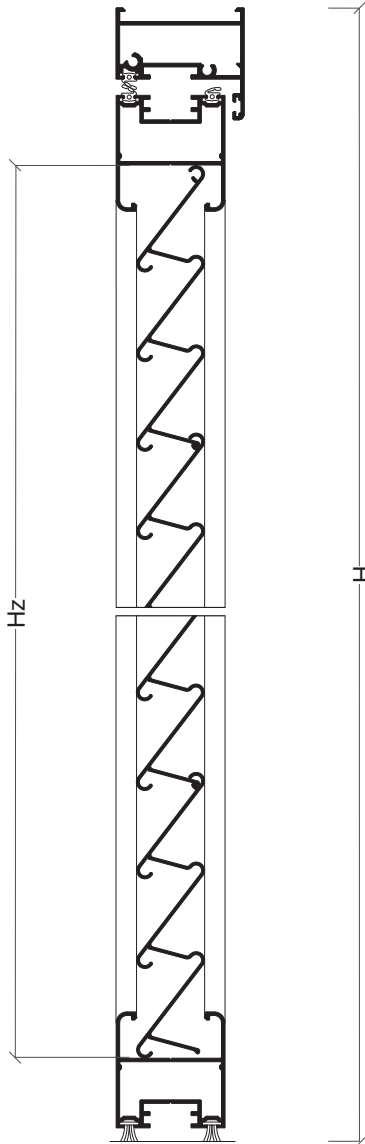
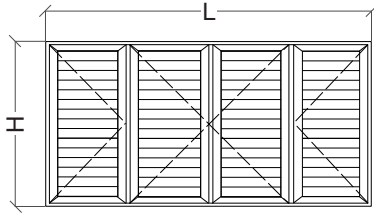



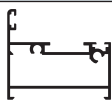





## Janela 4 folhas abertura exterior



### Perfis

Desenho	Ref	Descrição	Corte	Quant	Medida
	XP-03	Aro fixo		1	L
				2	H
	XP-05	Aro móvel de janela		4	Lat. = L/4-8 mm
				4	Cen. = L/4-33 mm
				8	H-37 mm
	Z-20	Lâmina		Segundo altura	Lat. = L/4-107 mm
				Segundo altura	Cen. = L/4-132 mm
	XP-04	Perfil de batente		4	H-37 mm

### Acessórios e Juntas

Referência	Descrição	Quantidade
30 94 01 02	Complemento fecho de portada	4
30 94 01 10	Fixador de portada 3/4 folhas (opcional)	2
30 94 01 12	Jogo topos para perfil batente	4
30 94 01 24	Dobradiça XP 1 <sup>3</sup> /2 <sup>a</sup> folha	4
30 94 01 25	Dobradiça XP 3 <sup>3</sup> /4 <sup>a</sup> folha	4
30 94 01 27	Esquadro de janela	18
30 94 01 40	Distanciador 14 mm abertura exterior	2
30 94 01 46	Junta interior/exterior	2L+4L/4+14H
30 95 00 30	Pelúcia 7x7 mm	8L/4
DIN 4131	Cremone abertura exterior	1
DIN 5040	Fecho 2 <sup>a</sup> folha	6
DIN 5099	Ponteira	2
DIN 10001 Inox	Fixador de portada (opcional)	2

35

### Portalâminas



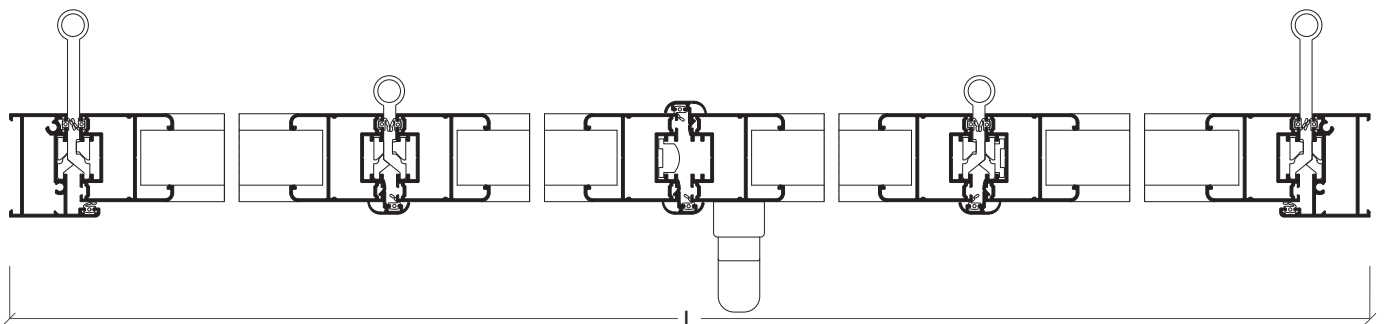



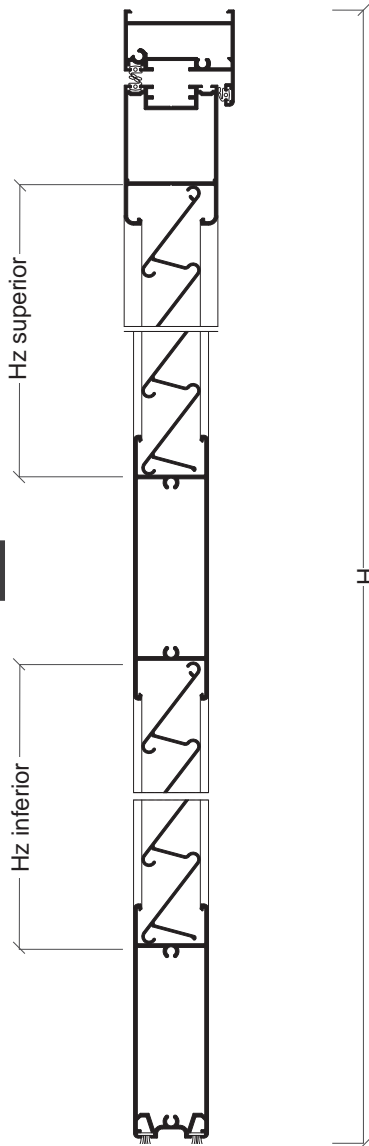
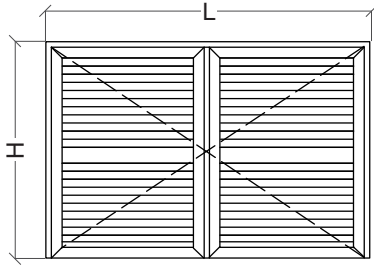



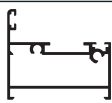

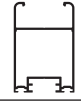
Hz = H-122 mm
---------------



## Porta 2 folhas abertura exterior



### Perfis

Desenho	Ref	Descrição	Corte	Quant	Medida
	XP-03	Aro fixo		1	L
				2	H
	XP-18	Aro móvel de porta		2	L/2-35 mm
				4	H-37 mm
	XP-27	Travessa		1	
	XP-16	Almofada 100 mm		4	L/2-154 mm
	Z-20	Lâmina		Segundo altura	L/2-168 mm
	XP-04	Perfil de batente		2	H-37 mm

### Acessórios e Juntas

Referência	Descrição	Quantidade
30 94 01 02	Complemento fecho de portada	2
30 94 01 12	Jogo topos para perfil batente	2
30 94 01 13	Tampa da folha	4
30 94 01 24	Dobradiça XP 1ª/2ª folha	8
30 94 01 27	Esquadro de janela	2
30 94 01 33	Esquadro porta	4
30 94 01 40	Distanciador 14 mm abertura exterior	2
30 94 01 46	Junta interior/exterior	2L+2L/2+8H
30 95 00 30	Pelúcia 7x7 mm	4L/2
DIN 4131	Cremona abertura exterior	1
DIN 5040	Fecho 2ª folha	6
DIN 5099	Ponteira	1

### Portalâminas

Hz superior = H1-148 mm
Hv inferior = H2-161 mm

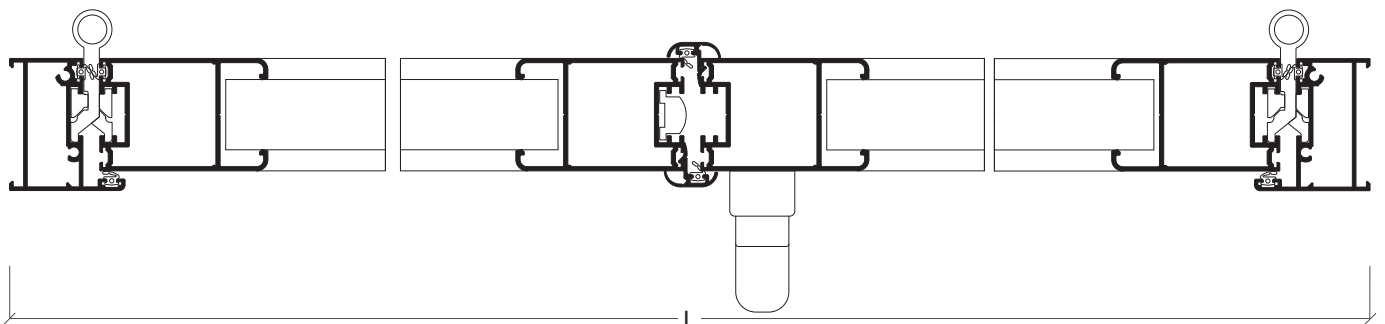

## Porta 3 folhas harmónio abertura exterior

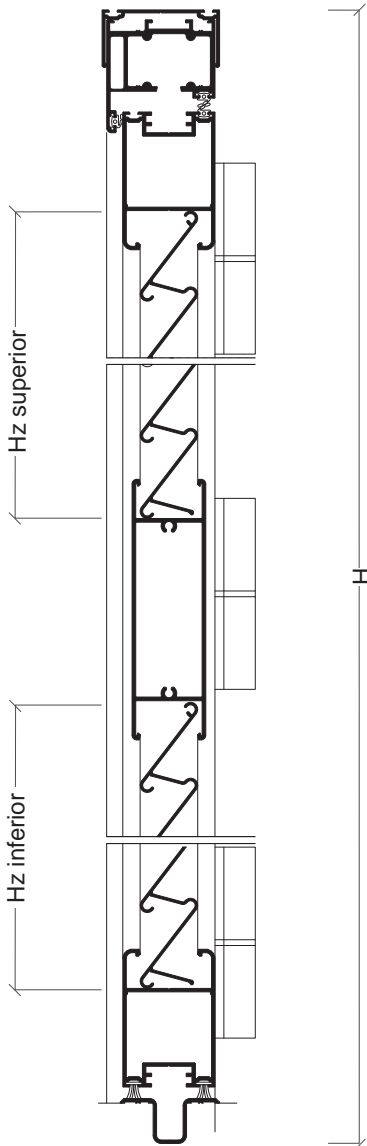
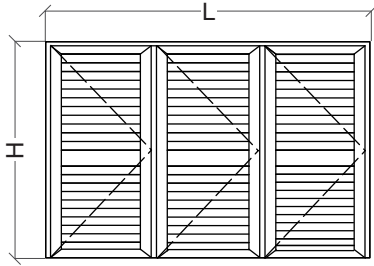

### Perfis

Desenho	Ref	Descrição	Corte	Quant	Medida
	XP-20	Distanciador de aro		1	L
	XP-21	Aro fixo para carril		1	L
	XP-03	Aro fixo		2	H-31 mm
	XP-18	Aro móvel de porta		6	L/3-25 mm
				6	H-47 mm
	XP-27	Travessa		3	L/3-145 mm
	Z-20	Lâmina		Segundo altura	L/3-158 mm
	XP-23	Guia de embutir		1	L

Dimensões máximas: 800x2500 mm por folha  
Peso máximo: 40 Kg por folha

### Acessórios e Juntas

Referência	Descrição	Quantidade
30 94 01 04	Jogo parafusos distanciadores	2
30 94 01 06	Rolamentos/dobradiças harmónio	1
30 94 01 07	Fecho de embutir portada	2
30 94 01 08	Aplique fixador	2
30 94 01 24	Dobradiça XP 1ª/2ª folha	8
30 94 01 26	Distanciador de pavimento	4
30 94 01 32	Distanciador chão	8
30 94 01 33	Esquadro porta	12
30 94 01 46	Junta interior/exterior	2L+3L/3+14H
30 95 00 30	Pelúcia 7x7 mm	6L/3
DIN 5099	Ponteira	8

37

### Portalâminas

Hz superior = H1-156 mm
Hz inferior = H2-123 mm

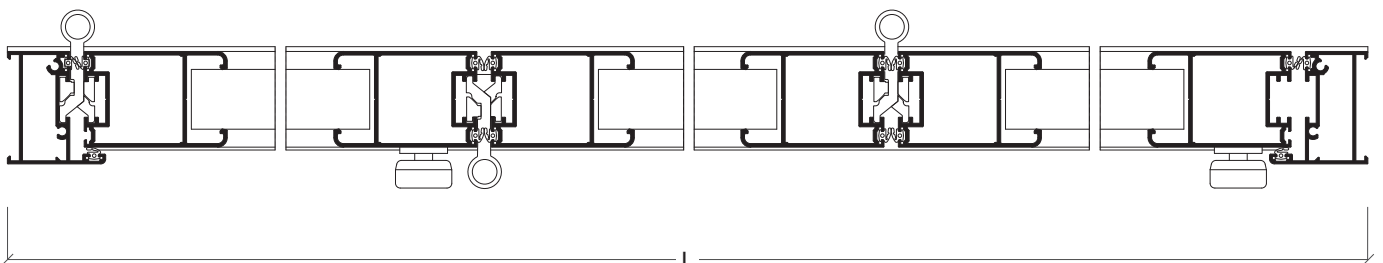

## Porta 5 folhas harmónio abertura exterior com vidro

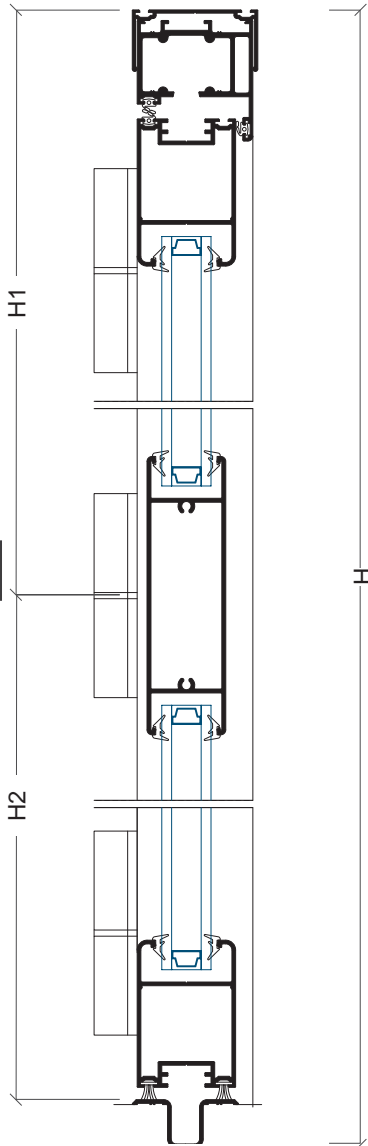
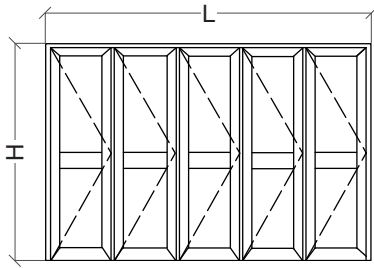

### Perfis

Desenho	Ref	Descrição	Corte	Quant	Medida
	XP-20	Distanciador de aro		1	L
	XP-21	Aro fixo para carril		1	L
	XP-03	Aro fixo		2	H-31 mm
	XP-18	Aro móvel de porta		10	L/5-17 mm
				10	H-47 mm
	XP-27	Travessa		5	L/5-103 mm
	XP-23	Guia de embutir		1	L

Dimensões máximas: 800x2500 mm por folha  
Peso máximo: 40 Kg por folha

### Acessórios e Juntas

Referência	Descrição	Quantidade
30 94 01 04	Jogo parafusos distanciadores	3
30 94 01 07	Fecho de embutir portada	3
30 94 01 08	Aplique fixador	3
30 94 01 06	Rolamentos/dobradiças harmónio	2
30 94 01 24	Dobradiça XP 1 <sup>ª</sup> /2 <sup>a</sup> folha	11
30 94 01 26	Distanciador de aro	1 a cada 50 cm
30 94 01 33	Esquadro porta	20
30 94 01 46	Junta interior/exterior	2L+5L/5+22H
30 95 00 30	Pelúcia 7x7 mm	10L/5
DIN 5099	Ponteira	12
---	Junta exterior vidro	4L+10H
---	Junta interior vidro	4L+10H

### Vidros



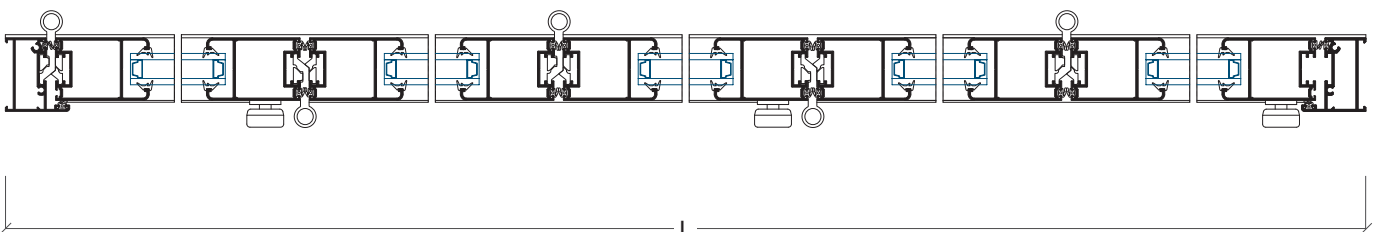



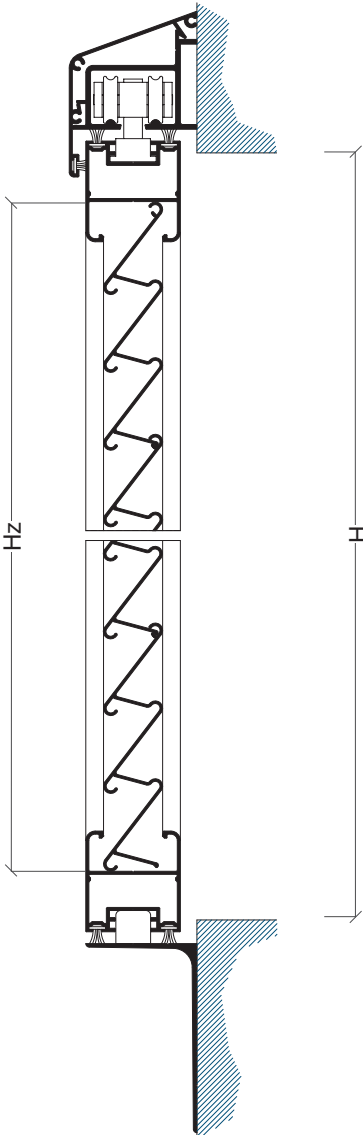
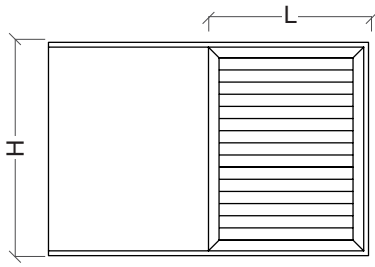





L/5-126 mm	H1-123 mm
L/5-126 mm	H2-90 mm



## Janela 1 folha correr



### Perfis

Desenho	Ref	Descrição	Corte	Quant	Medida
	XP-07	Guia superior de correr		1	2L+59 mm
	XP-05	Aro móvel de janela		2	L+10 mm
				2	L+10 mm
	Z-20	Lâmina		Segundo altura	L-89 mm
	XP-06	Tampa da guia superior		1	2L+59 mm
	XP-08	Tampa lateral de correr		2	H+10 mm
	XP-15	Guia inferior de correr		1	2L+59 mm

### Acessórios e Juntas

Referência	Descrição	Quantidade
30 94 01 04	Jogo parafusos distanciadores	1
30 94 01 05	Rolamentos portada de correr	2
30 94 01 07	Fecho de embutir portada	1
30 94 01 27	Esquadro de janela	4
30 94 01 34	Fecho superior correr	2
30 94 01 35	Fecho inferior correr	2
30 94 01 36	Tampa lateral	2
30 95 00 10	Pelúcia 7x9 mm	4L+2H+12L
DIN 5099	Ponteira	2

39

### Portalâminas



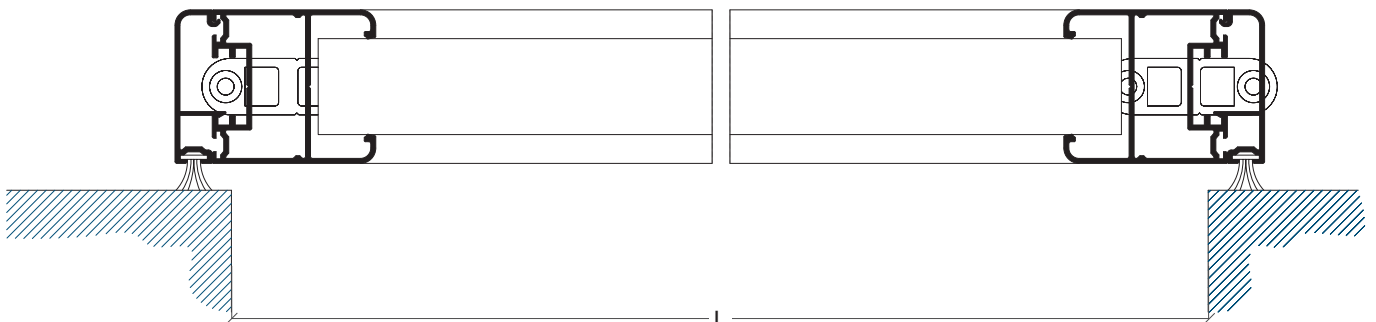



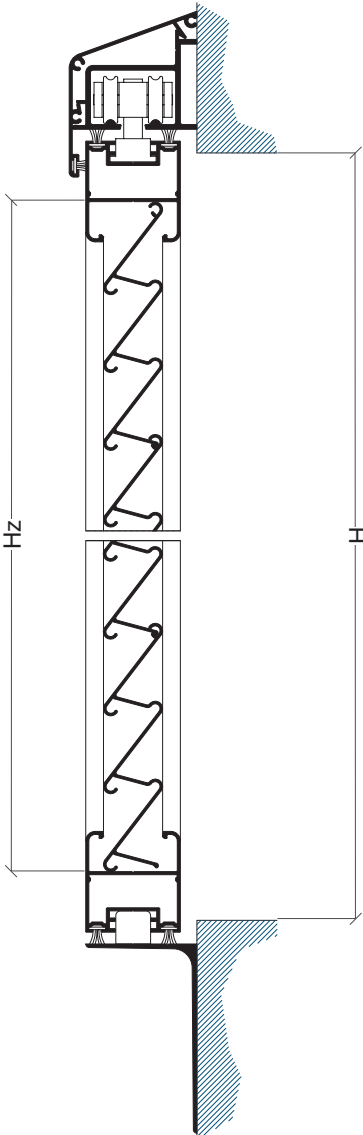
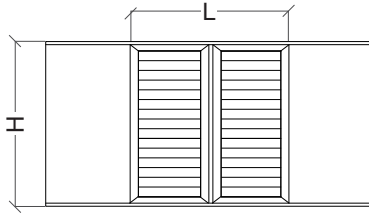





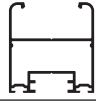

Hz = H-75 mm
--------------



## Janela 2 folhas correr



### Perfis

Desenho	Ref	Descrição	Corte	Quant	Medida
	XP-07	Guia superior de correr		1	2L+19 mm
	XP-05	Aro móvel de janela		4	L/2 mm
				4	H+10 mm
	Z-20	Lâmina		Segundo altura	L/2-99 mm
	XP-06	Tampa da guia superior		1	2L+19 mm
	XP-08	Tampa lateral de correr		2	H+10 mm
	XP-15	Guia inferior de correr		1	2L+19 mm
	XP-17	Perfil de batente		2	H-7 mm

### Acessórios e Juntas

Referência	Descrição	Quantidade
30 94 01 04	Jogo parafusos distanciadores	2
30 94 01 05	Rolamentos portada de correr	4
30 94 01 07	Fecho de embutir portada	2
30 94 01 12	Jogo topos para perfil batente	2
30 94 01 27	Esquadro de janela	8
30 94 01 34	Fecho superior correr	3
30 94 01 35	Fecho inferior correr	3
30 94 01 36	Tampa lateral	2
30 95 00 10	Pelúcia 7x9 mm	8L/2+4H+12L
DIN 5099	Ponteira	4

### Portalâminas

Hz = H-75 mm
--------------

