

Sistema

CL

Sistema CL

Sistema de correr - 78 mm

Características dos sistemas CL/CL Plus

Sistemas de alumínio para execução de vãos de correr ou janelas duplas com rotura térmica.

Perfis de alumínio

Os perfis de alumínio são extrudidos na liga de alumínio 6060 para arquitetura de acordo com norma NP EN 12020-02.

Aros fixos

Secção do aro fixo de 2 guias de 70 mm para montagem a corte recto;

Secção do aro fixo janela dupla de 196 mm para montagem a corte recto.

Aros móveis

Secção dos aros móveis de 28 mm com montagem a corte recto;

Enchimento de 4 mm a 18 mm;

Estanquidade assegurada através de pelúcia tipo Fin-Seal.

Dimensionamento e manobralidade

Peso máximo de 80 kg por folha (com 2 rolamentos duplos);

Possibilidades de abertura: 2, 3 e 4 folhas, com folhas móveis e/ou fixas;

Performances

Sistema certificado por laboratório notificado do ensaio tipo inicial (ITT) de acordo com a norma de produto EN 14351-1 para efeitos de Marcação CE.

Categorias alcançadas na avaliação do sistema CL tipologia janela:

1. Permeabilidade ao ar: Classe 3 (norma de ensaio EN 1026)
2. Estanquidade à água: Classe 7A (norma de ensaio EN 1027)
3. Resistência ao vento: Classe C3 (norma de ensaio EN 12211)

Categorias alcançadas na avaliação do sistema CL tipologia porta:

1. Permeabilidade ao ar: Classe 3 (norma de ensaio EN 1026)
2. Estanquidade à água: Classe 7A (norma de ensaio EN 1027)
3. Resistência ao vento: Classe B2 (norma de ensaio EN 12211)

Coefficiente de transmissão térmica de vão de 2 folhas com 1.80 m x 2.20m com vidro $U_g = 1.8 \text{ W/m}^2\text{K}$ com intercalar efeito "Warm Edge":

- $U_w = 2.98 \text{ W/m}^2\text{K}$

Coefficiente de atenuação acústica de vão de 2 folhas com vidro 4/10/4 acústico:

- $R_w (C; C_{tr}) = 28 \text{ dB} (-1; -1)$

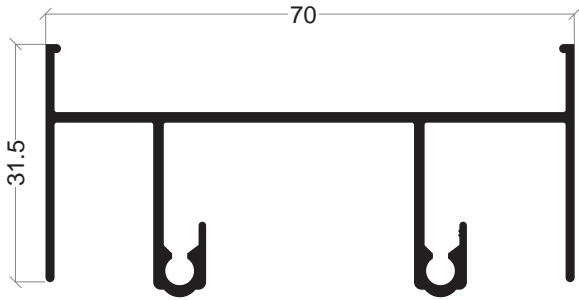

CL-05
Padeira

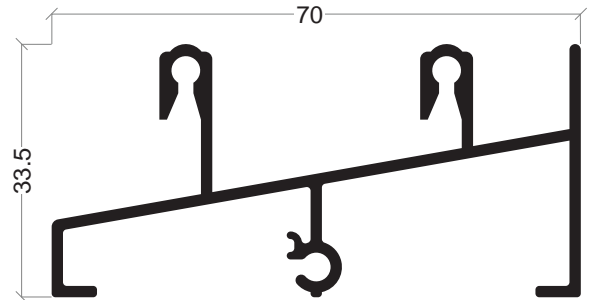

CL-61
Soleira

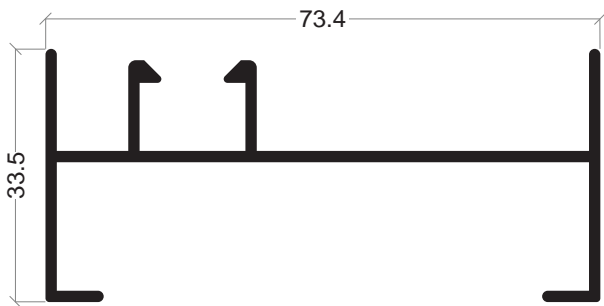

CL-06
Ombreira

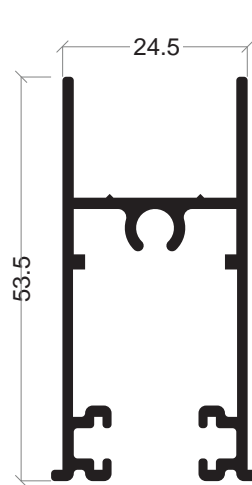

CL-10
Móvel carrinho

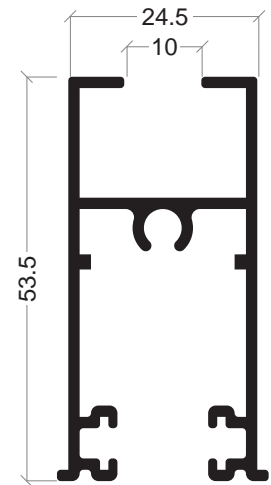

CL-12
Móvel carrinho

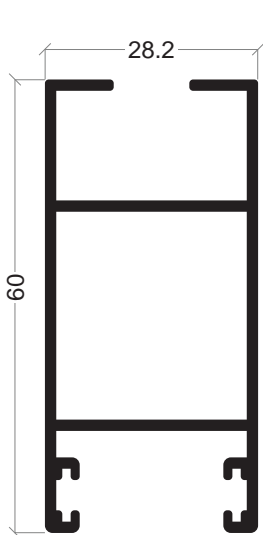

CL-19
Móvel lateral

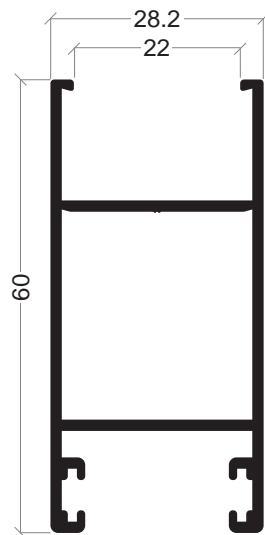

CL-20
Móvel lateral

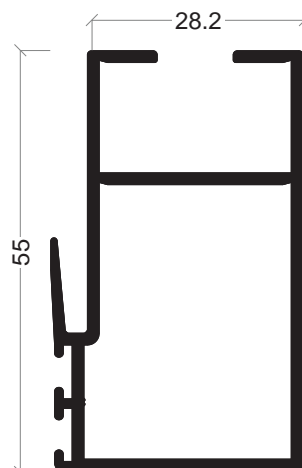

CL-17
Móvel central

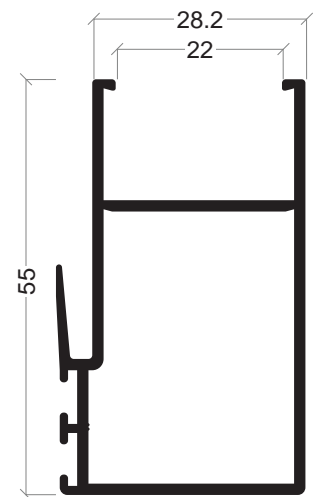

CL-09
Móvel central

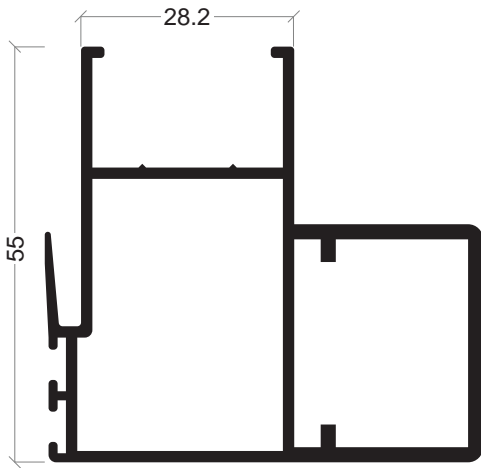

CL-27
Móvel central com reforço

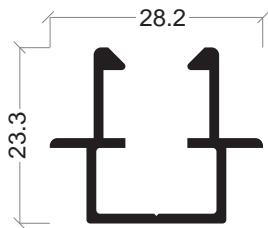

CL-28
União 3/4F

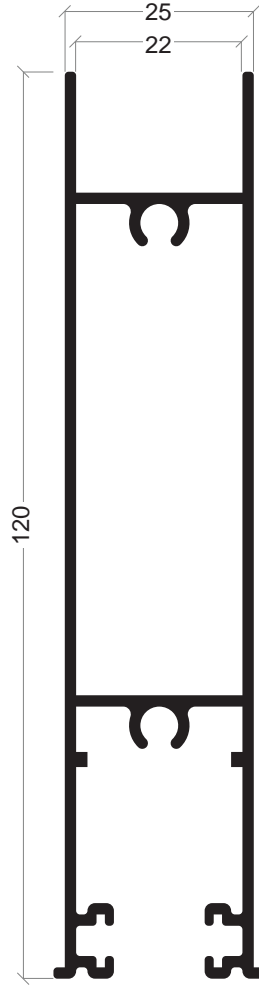

CL-52
Almofada carrinho

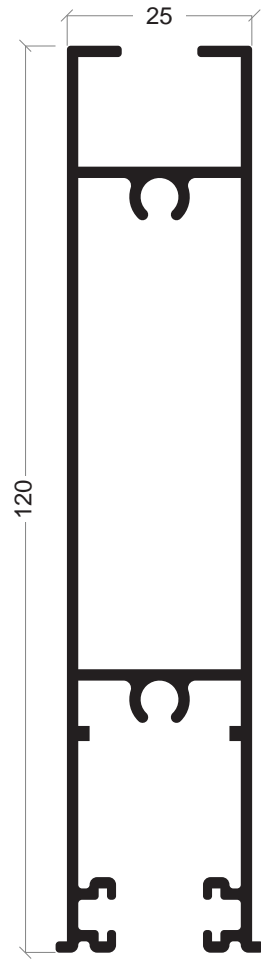

CL-72
Almofada carrinho

20

Perfis alternativos

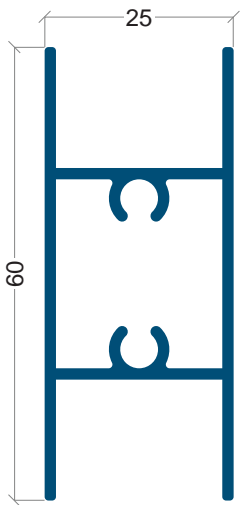

CL-53
Travessa

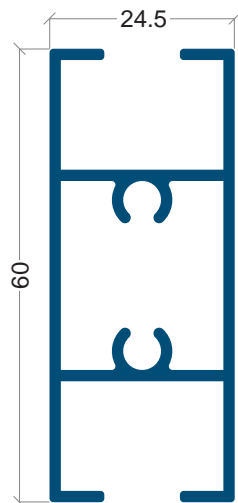

CL-73
Travessa

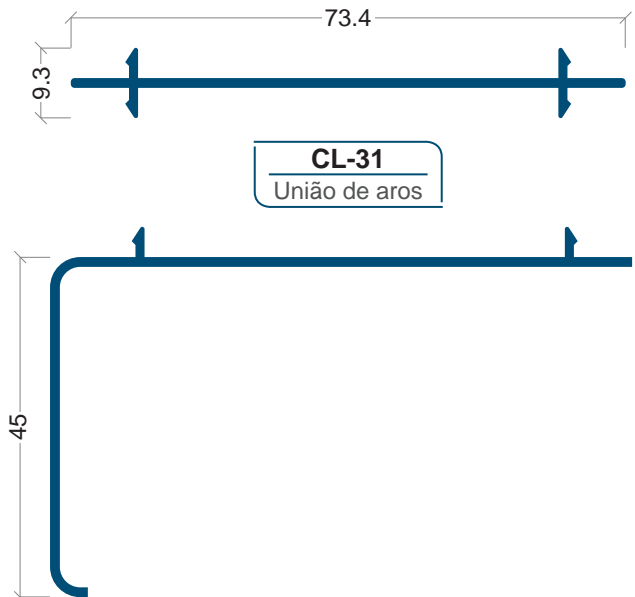

CL-31
União de aros

CL-26
Remate

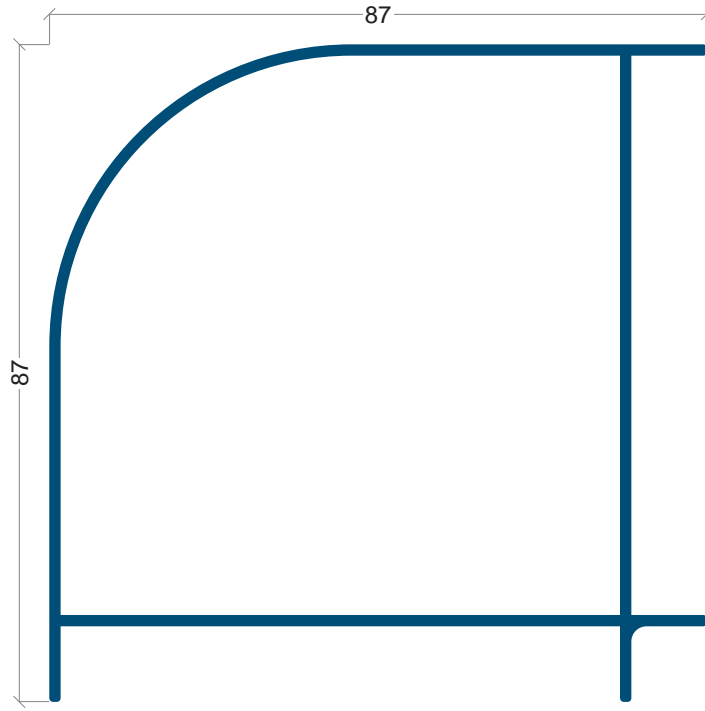

CL-30
Esquina

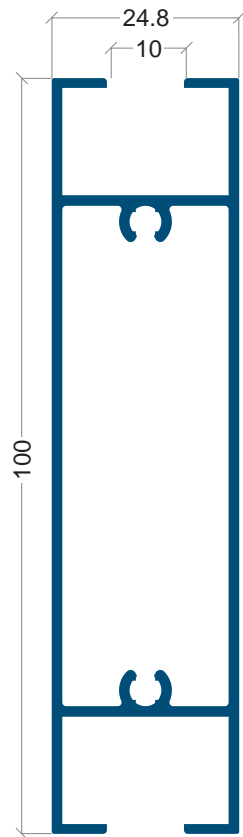

CL-25
Travessa

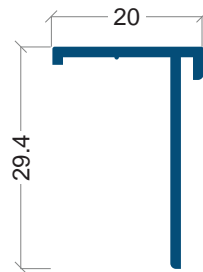

Y-24
Remate p/ apanelado

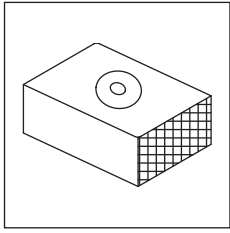

30 91 41 10
Taco anti-levantamento
preto

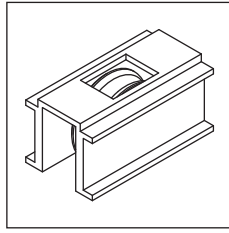

30 91 50 22
Rolamento simples CL-
10/12/52/72

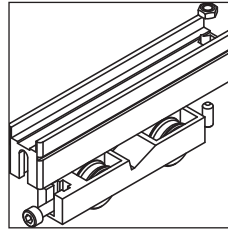

30 91 50 24
Rolamento duplo
regulável (80Kg/folha)

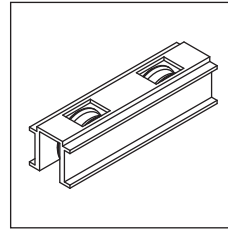

30 91 50 27
Rolamento duplo CL-
10/12/52/72

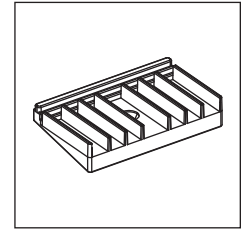

30 91 50 30
Corta-vento inferior CL

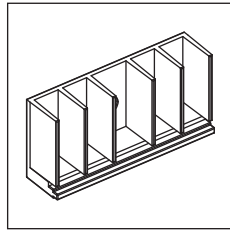

30 91 50 40
Corta-vento superior
CL-05

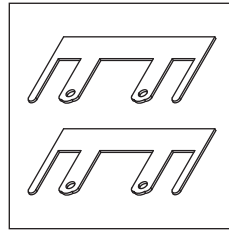

30 91 50 61
Junta estaquidade
superior CL-05

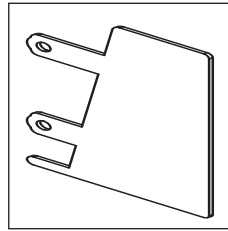

30 91 50 70
Junta estanquidade inf.
CL-61

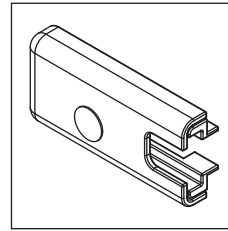

30 91 50 80
Tampa guia lateral CL

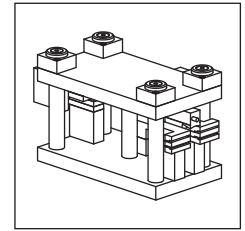

33 95 99 99
Cunho CL

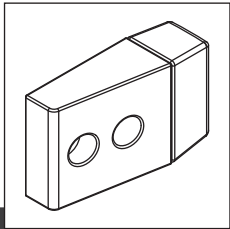

30 91 41 71
Topo limitador de
abertura

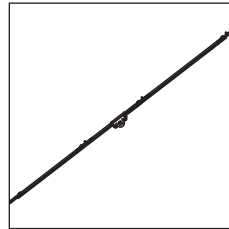

DIN 4200
Fecho multiponto
Inox

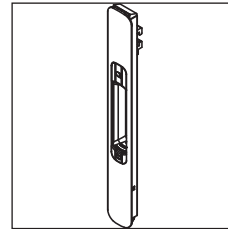

DIN 4352
Fecho de embutir



DIN 4364
Acessórios fecho de
embutir

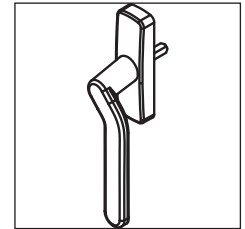







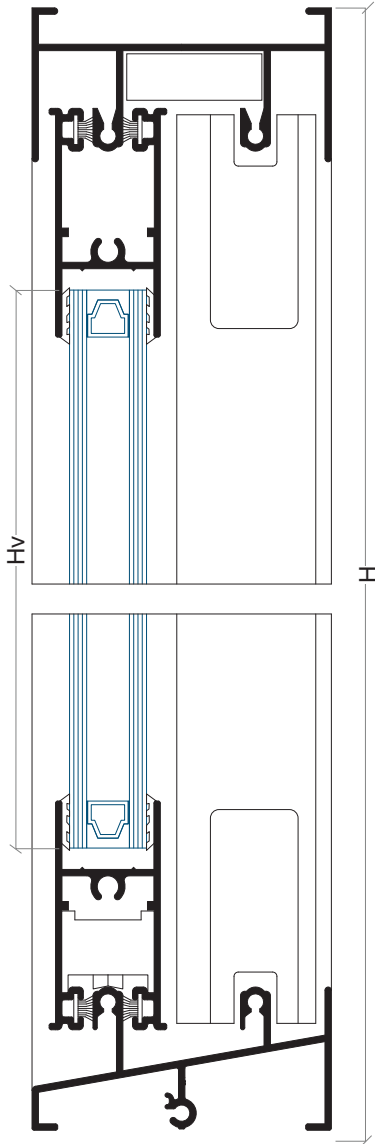
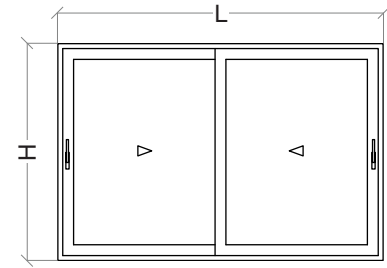

DIN 4520
Muleta desviada

Referência	Desenho	Descrição
30 95 00 40		Pelúcia 7x5.5
30 95 00 70		Pelúcia 7x3.5
30 95 00 80		Pelúcia 7x5
30 93 00 67		Junta interior para vidro (2mm)
30 93 00 66		Junta interior para vidro (4mm)
30 93 00 65		Junta interior para vidro (5mm)
30 93 00 68		Junta interior para vidro (6/7mm)
30 93 00 69		Junta interior para vidro (8/9mm)

Janela correr 2 folhas



Perfis

Desenho	Ref	Descrição	Corte	Quant	Medida
	CL-05	Padieira		1	L-40
	CL-61	Soleira		1	L-40
	CL-06	Ombreira		2	H
	CL-10	Móvel carrinho		4	L/2-12
	CL-20	Móvel lateral		2	H-50
	CL-09	Móvel central		2	H-50

Acessórios e Juntas

Referência	Descrição	Quantidade
30 91 41 10	Taco anti-levantamento	2
30 91 50 22	Rolamentos	4
30 91 50 30	Corta ventos inferior	1
30 91 50 40	Corta ventos superior	1
30 91 50 61	Junta estanquidade superior	1
30 91 50 70	Junta estanquidade inferior	1
30 91 50 80	Tampa guia lateral	4
30 95 00 40	Pelúcia 7x5.5	4L
30 95 00 70	Pelúcia 7x3.5 (lateral)	4H
30 95 00 80	Pelúcia 7x5 (central)	4H
DIN 4352	Fecho de embutir	2
DIN 4364	Acessórios fecho de embutir	2

23

Vidro



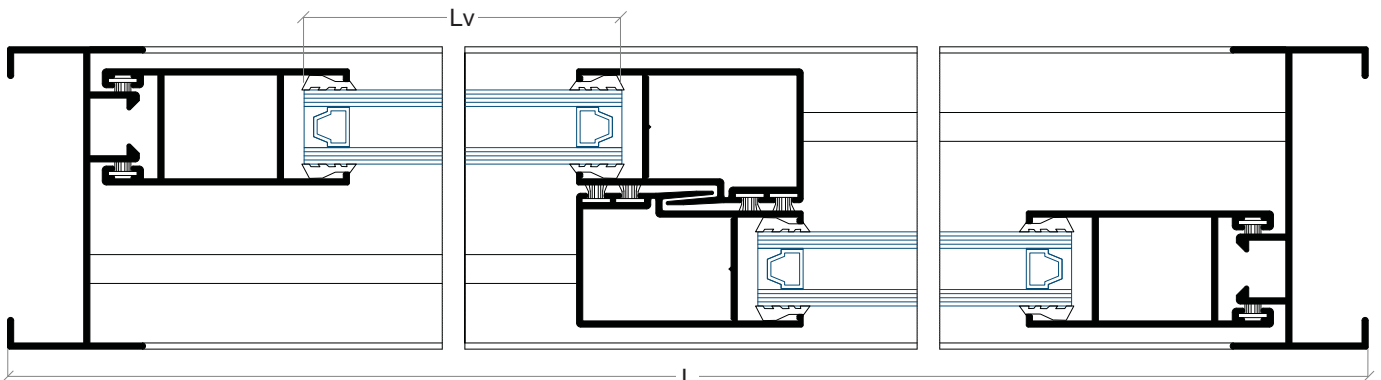



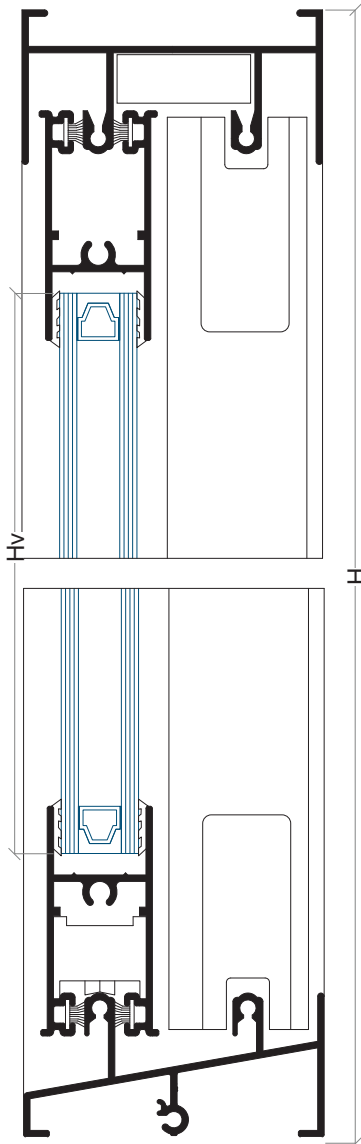
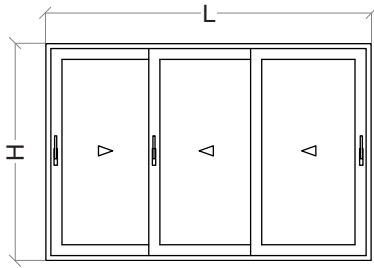

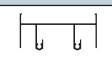

Hv = H-132mm	Lv = L/2-89mm
--------------	---------------

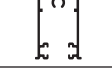

Janela correr 3 folhas

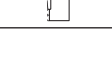

Perfis

Desenho	Ref	Descrição	Corte	Quant	Medida
	CL-05	Padieira		1	L-40
	CL-61	Soleira		1	L-40
	CL-06	Ombreira		2	H
	CL-10	Móvel carrinho		4	L/3+7
				2	L/3+15
	CL-20	Móvel lateral		2	H-50
	CL-09	Móvel central		4	H-50

Acessórios e Juntas

Referência	Descrição	Quantidade
30 91 41 10	Taco anti-levantamento	2
30 91 50 22	Rolamentos	6
30 91 50 30	Corta ventos inferior	2
30 91 50 40	Corta ventos superior	2
30 91 50 61	Junta estanquidade superior	1
30 91 50 70	Junta estanquidade inferior	1
30 91 50 80	Tampa guia lateral	8
30 95 00 40	Pelúcia 7x5.5	12L/3
30 95 00 70	Pelúcia 7x3.5 (lateral)	4H
30 95 00 80	Pelúcia 7x5 (central)	4H
DIN 4352	Fecho de embutir	2
DIN 4364	Acessórios fecho de embutir	2

Vidro



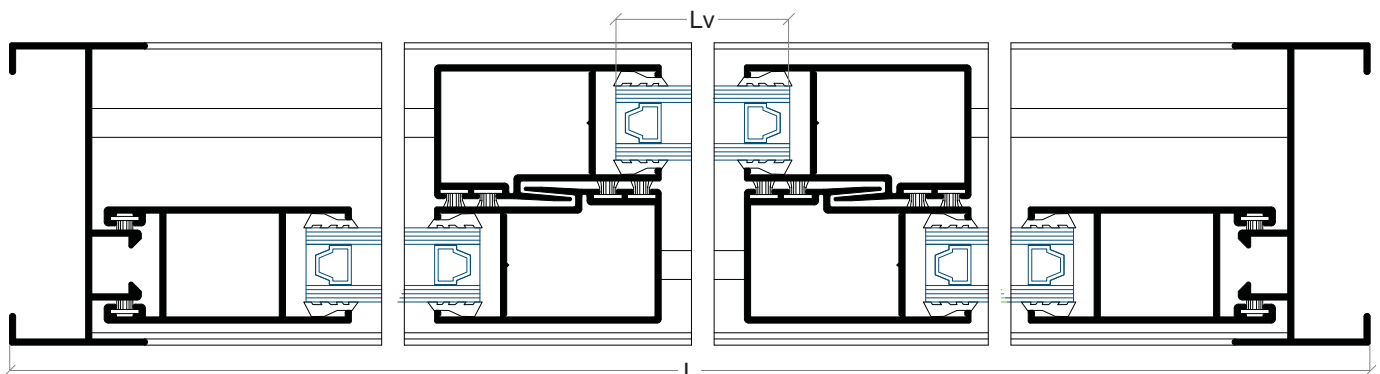



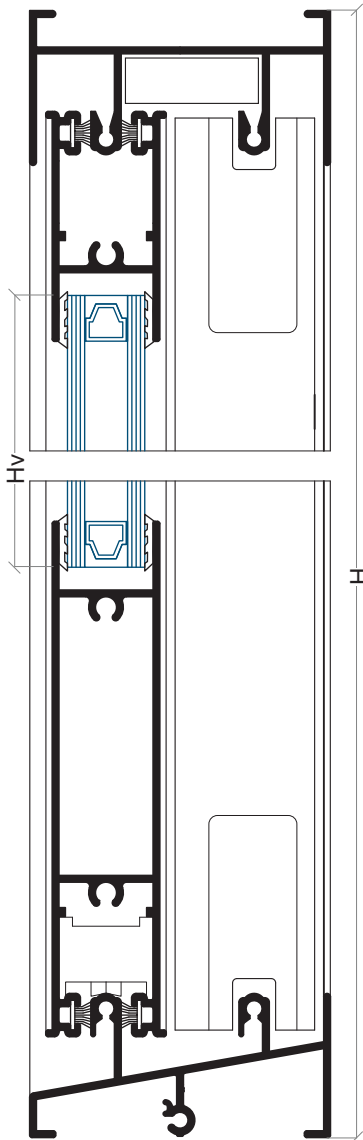
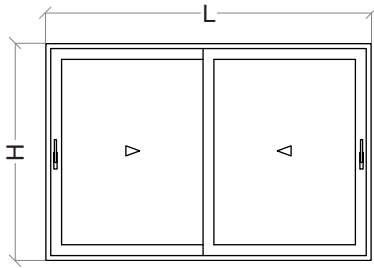







Hv = H-132mm	Lv = L/3-68mm
--------------	---------------



Porta correr 2 folhas



Perfis

Desenho	Ref	Descrição	Corte	Quant	Medida
	CL-05	Padieira		1	L-40
	CL-61	Soleira		1	L-40
	CL-06	Ombreira		2	H
	CL-10	Móvel carrinho		4	L/2-12
	CL-20	Móvel lateral		2	H-50
	CL-27	Móvel central		2	H-50
	CL-52	Almofada		2	L/2-12

Acessórios e Juntas

Referência	Descrição	Quantidade
30 91 41 10	Taco anti-levantamento	2
30 91 50 27	Rolamentos	4
30 91 50 30	Corta ventos inferior	1
30 91 50 40	Corta ventos superior	1
30 91 50 60	Junta estanquidade superior	1
30 91 50 70	Junta estanquidade inferior	1
30 91 50 80	Tampa guia lateral	4
30 95 00 40	Pelúcia 7x5.5	4L
30 95 00 70	Pelúcia 7x3.5 (lateral)	4H
30 95 00 80	Pelúcia 7x5 (central)	4H
DIN 4352	Fecho de embutir	2
DIN 4364	Acessórios fecho de embutir	2

25

Vidro



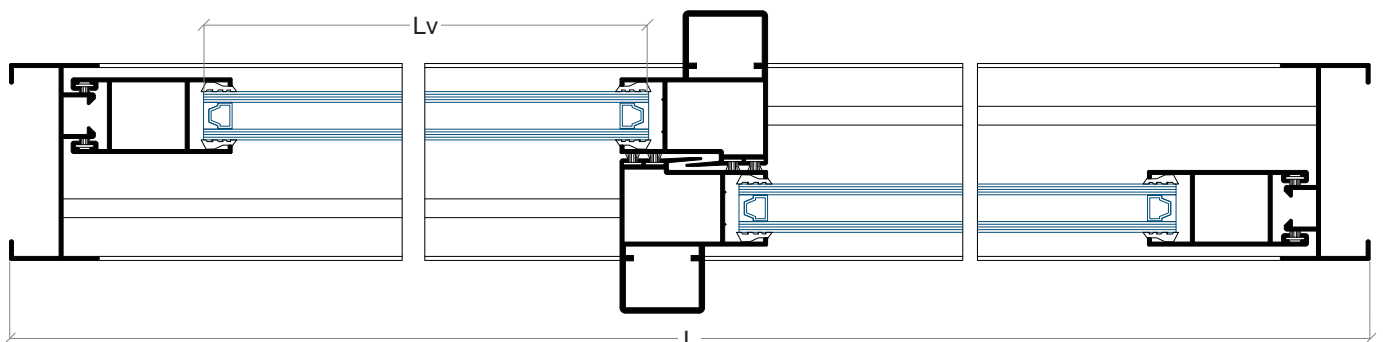



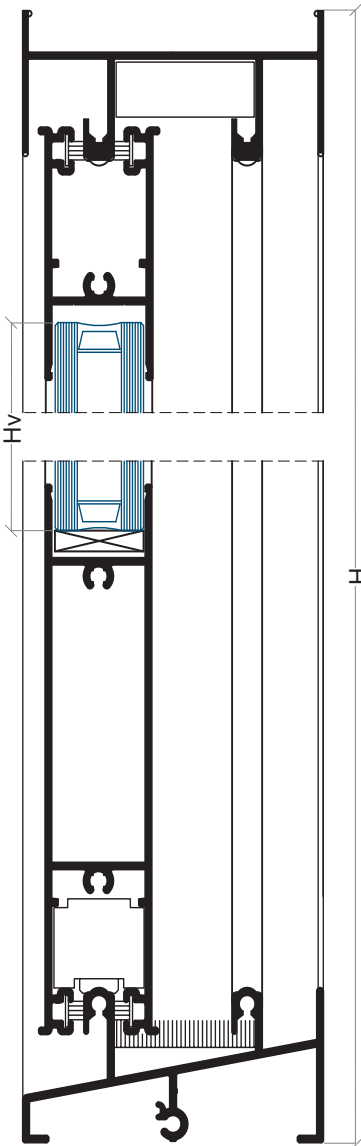
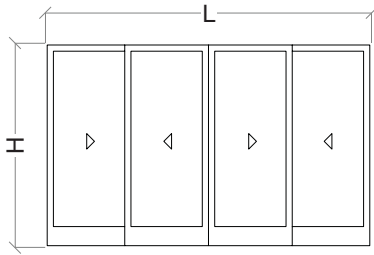









Hv = H-199mm	Lv = L/2-89mm
--------------	---------------



Porta correr 4 folhas



Perfis

Desenho	Ref	Descrição	Corte	Quant	Medida
	CL-05	Padieira		1	L-40
	CL-61	Soleira		1	L-40
	CL-06	Ombreira		2	H
	CL-10	Móvel carrinho		4	L/4-2
	CL-20	Móvel lateral		4	H-50
	CL-09	Móvel central		4	H-50
	CL-52	Almofada		4	L/4-2
	CL-28	Perfil 4 folhas		1	H-50

Acessórios e Juntas

Referência	Descrição	Quantidade
30 91 41 10	Taco anti-levantamento	3
30 91 50 27	Rolamentos	8
30 91 50 30	Corta ventos inferior	3
30 91 50 40	Corta ventos superior	3
30 91 50 61	Junta estanquidade superior	1
30 91 50 71	Junta estanquidade inferior	1
30 91 50 80	Jogo guias lateral	8
30 95 00 40	Pelúcia 7x5.5	4L
30 95 00 70	Pelúcia 7x3.5 (lateral)	6H
30 95 00 80	Pelúcia 7x5.5 (central)	8H
DIN 4352	Fecho de embutir	3
DIN 4364	Acessórios fecho de embutir	3

Vidro

Hv = H-199mm	Lv = L/4-76mm
--------------	---------------

